

描述 / Descriptions

TO-220 塑封封装 NPN 半导体三极管。Silicon NPN transistor in a TO-220 Plastic Package.

特征 / Features

基极-发射极设有独立的电阻、直流增益高、与 TIP147T 配对。

Monolithic construction with built in base-emitter shunt resistors, High DC current gain complement to TIP147T.

用途 / Applications

用于工业仪器的线性开关转换。

Linear and switching industrial equipment.

内部等效电路 / Equivalent Circuit

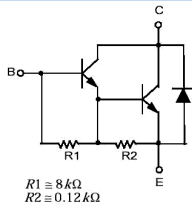

引脚排列 / Pinning

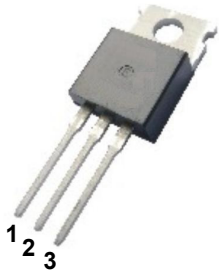

PIN 1 : Base PIN 2 : Collector PIN 3 : Emitter

放大及印章代码 / h_{FE} Classifications & Marking

见印章说明。See Marking Instructions.

极限参数 / Absolute Maximum Ratings(Ta=25°C)

参数 Parameter	符号 Symbol	数值 Rating	单位 Unit
Collector to Base Voltage	V_{CBO}	100	V
Collector to Emitter Voltage	V_{CEO}	100	V
Emitter to Base Voltage	V_{EBO}	5	V
Collector Current - Continuous	I_C	10	A
Peak Collector Current	I_{CP}	15	A
Base Current - Continuous	I_B	0.5	A
Collector Power Dissipation	$P_C(T_C=25^\circ\text{C})$	80	W
Junction Temperature	T_j	150	°C
Storage Temperature Range	T_{stg}	-55~150	°C

电性能参数 / Electrical Characteristics(Ta=25°C)

参数 Parameter	符号 Symbol	测试条件 Test Conditions	最小值 Min	典型值 Typ	最大值 Max	单位 Unit
Collector to Emitter Breakdown Voltage	V_{CEO}	$I_C=30\text{mA}$ $I_B=0$	100			V
Collector Cut-Off Current	I_{CEO}	$V_{CE}=50\text{V}$ $I_B=0$			2	mA
Collector Cut-Off Current	I_{CBO}	$V_{CB}=100\text{V}$ $I_E=0$			1	mA
Emitter Cut-Off Current	I_{EBO}	$V_{EB}=5\text{V}$ $I_C=0$			2	mA
DC Current Gain	$h_{FE(1)}$	$V_{CE}=4\text{V}$ $I_C=5\text{A}$	1000			
	$h_{FE(2)}$	$V_{CE}=4\text{V}$ $I_C=10\text{A}$	500			
Collector to Emitter Saturation Voltage	$V_{CE(sat)(1)}$	$I_C=5\text{A}$ $I_B=10\text{mA}$			2	V
	$V_{CE(sat)(2)}$	$I_C=10\text{A}$ $I_B=40\text{mA}$			3	V
Base to Emitter Saturation Voltage	$V_{BE(sat)}$	$I_C=10\text{A}$ $I_B=40\text{mA}$			3.5	V
Base to Emitter Voltage	V_{BE}	$V_{CE}=4\text{V}$ $I_C=10\text{A}$			3	V
Delay Time	t_D	$V_{CC}=30\text{V}$ $I_C=5\text{A}$ $I_{B1}=20\text{mA}$ $I_{B2}=20\text{mA}$ $R_L=6\Omega$		0.15		μs
Rise Time	t_R			0.55		μs
Storage Time	t_{STG}			2.5		μs
Fall Time	t_F			2.5		μs

电参数曲线图 / Electrical Characteristic Curve

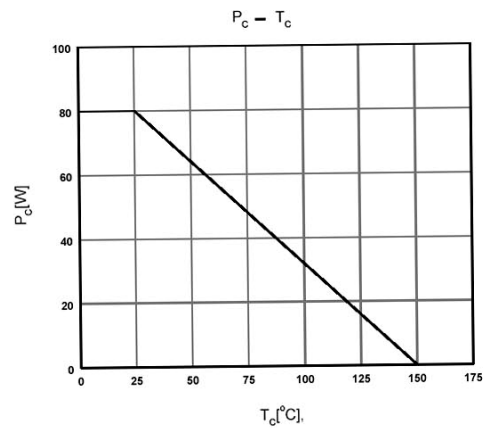
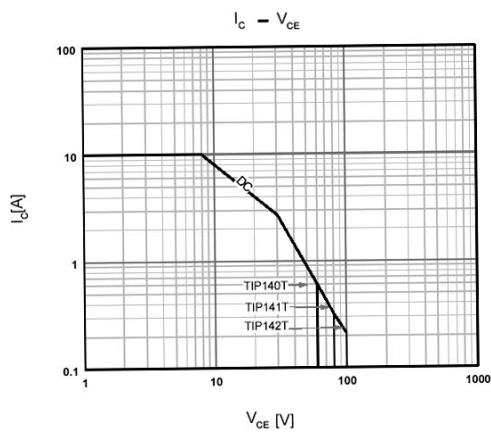
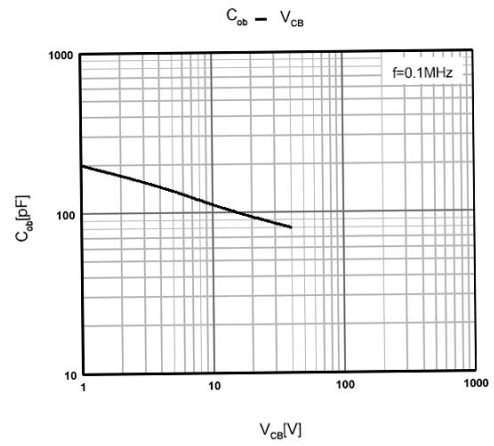
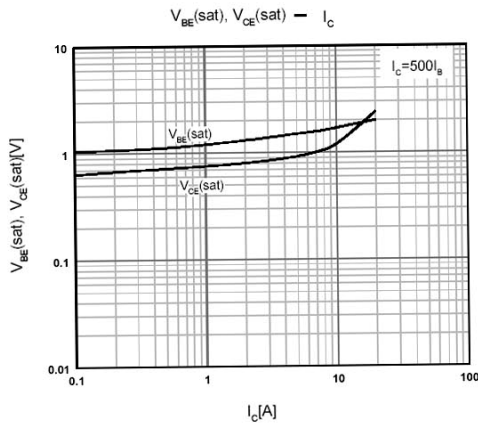
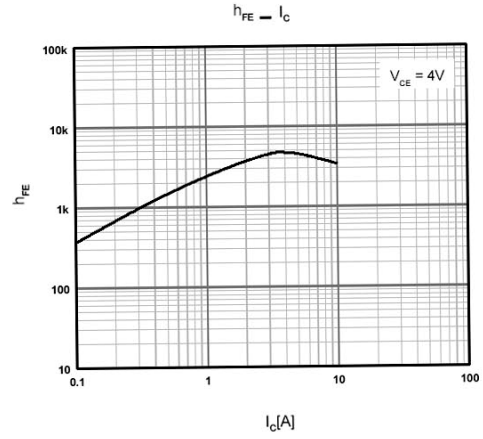
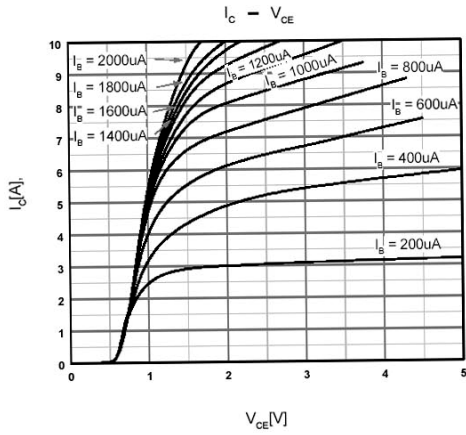

外形尺寸图 / Package Dimensions

T0-220

单位: mm

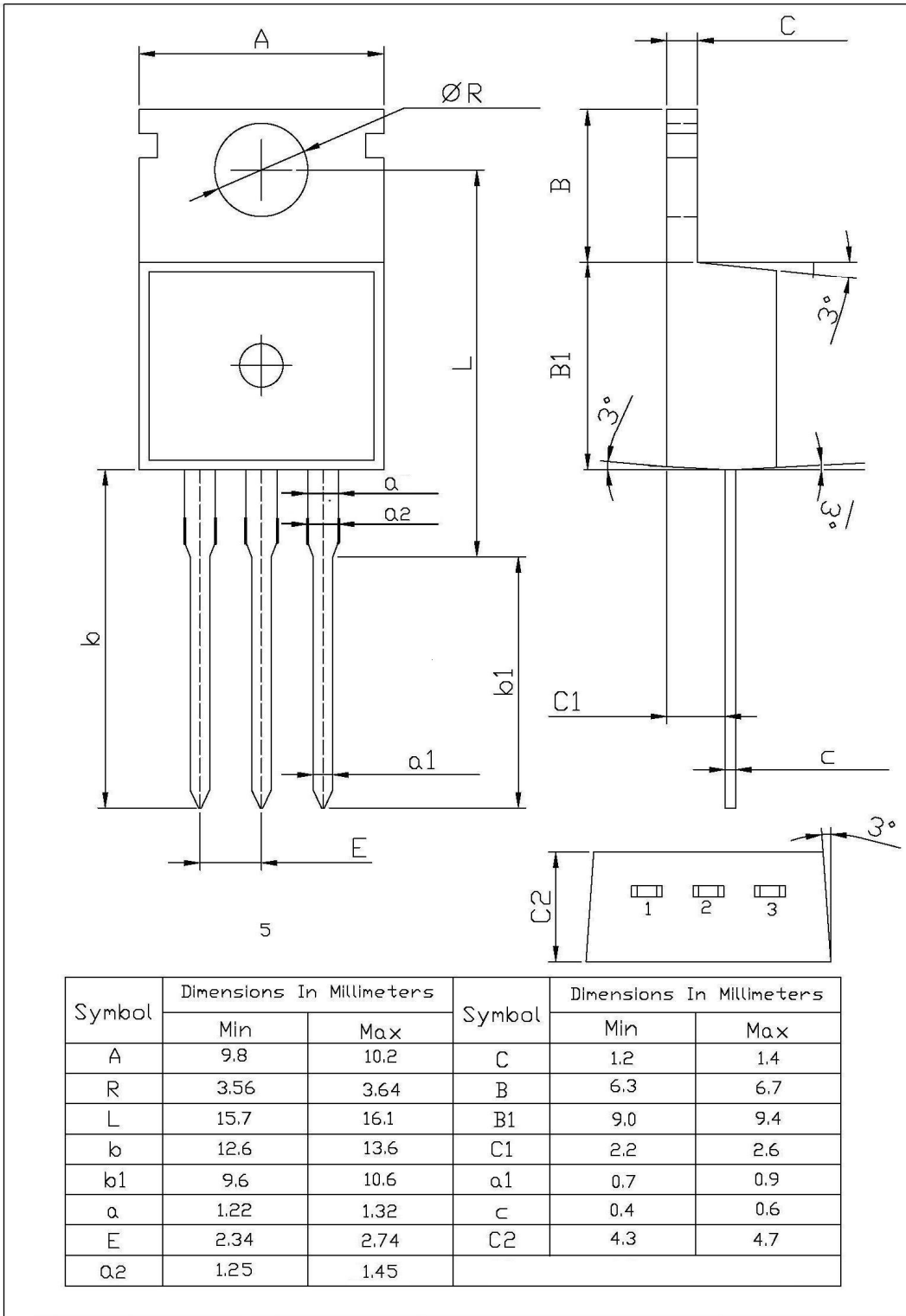

印章说明 / Marking Instructions

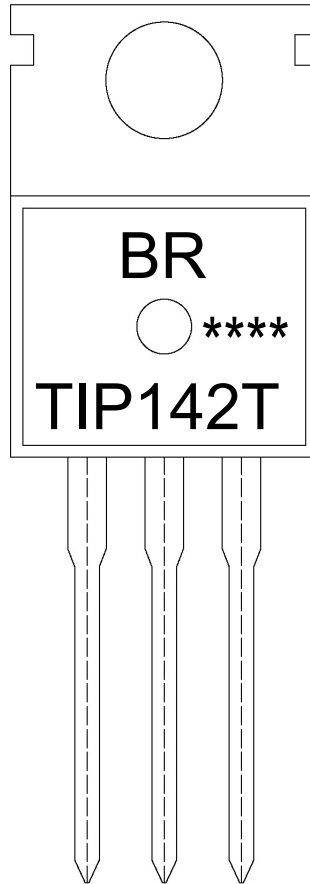

说明：

BR： 为公司代码

TIP142T： 为产品型号

****： 为生产批号代码，随生产批号变化。

Note:

BR: Company Code

TIP142T: Product Type.

****: Lot No. Code, code change with Lot No.

波峰焊温度曲线图(无铅) / Temperature Profile for Dip Soldering(Pb-Free)



说明：

- 1、预热温度 25 ~ 150°C，时间 60 ~ 90sec；
- 2、峰值温度 255±5°C，时间持续为 5±0.5sec；
- 3、焊接制程冷却速度为 2 ~ 10°C/sec.

Note:

- 1.Preheating:25~150°C, Time:60~90sec.
- 2.Peak Temp.:255±5°C, Duration:5±0.5sec.
3. Cooling Speed: 2~10°C/sec.

耐焊接热试验条件 / Resistance to Soldering Heat Test Conditions

温度：270±5°C 时间：10±1 sec. Temp.:270±5°C Time:10±1 sec

包装规格 / Packaging SPEC.

散件包装 / BULK

Package Type 封装形式	Units 包装数量					Dimension 包装尺寸 (unit: mm ³)		
	Units/Bag 只/袋	Bags/Inner Box 袋/盒	Units/Inner Box 只/盒	Inner Boxes/Outer Box 盒/箱	Units/Outer Box 只/箱	Bag 袋	Inner Box 盒	Outer Box 箱
TO-220/F	200	10	2,000	5	10,000	135×190	237×172×102	560×245×195

套管包装 / TUBE

Package Type 封装形式	Units 包装数量					Dimension 包装尺寸 (unit: mm ³)		
	Units/Tube 只/套管	Tubes/Inner Box 套管/盒	Units/Inner Box 只/盒	Inner Boxes/Outer Box 盒/箱	Units/Outer Box 只/箱	Tube 套管	Inner Box 盒	Outer Box 箱
TO-220/F	50	20	1,000	5	5,000	532×31.4×5.5	555×164×50	575×290×180

使用说明 / Notices