

### 描述 / Descriptions

TO-220F 塑封封装 NPN 半导体三极管。Silicon NPN transistor in a TO-220F Plastic Package.

### 特征 / Features

饱和压降低，与 KTB1366 互补。  
Low saturation voltage, complementary to KTB1366.

### 用途 / Applications

用于一般放大。  
General Purpose Application.

### 内部等效电路 / Equivalent Circuit

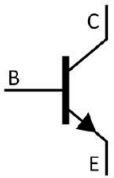

### 引脚排列 / Pinning



PIN1 : Base      PIN 2 : Collector      PIN 3 : Emitter

### 放大及印章代码 / $h_{FE}$ Classifications & Marking

$h_{FE}$ Classifications Symbol	O	Y
$h_{FE}$ Range	60~120	100~200

**极限参数 / Absolute Maximum Ratings(Ta=25°C)**

参数 Parameter	符号 Symbol	数值 Rating	单位 Unit
Collector to Base Voltage	$V_{CBO}$	60	V
Collector to Emitter Voltage	$V_{CEO}$	60	V
Emitter to Base Voltage	$V_{EBO}$	7.0	V
Collector Current - Continuous	$I_C$	3.0	A
Base Current	$I_B$	0.5	A
Collector Power Dissipation	$P_C$	2.0	W
Collector Power Dissipation	$P_C(T_c=25^\circ C)$	25	W
Junction Temperature	$T_j$	150	°C
Storage Temperature Range	$T_{sag}$	-55~150	°C

**电性能参数 / Electrical Characteristics(Ta=25°C)**

参数 Parameter	符号 Symbol	测试条件 Test Conditions	最小值 Min	典型值 Typ	最大值 Max	单位 Unit
Collector-Emitter Breakdown Voltage	$V_{CEO}$	$I_C=50mA$ $I_B=0$	60			V
Collector Cut-Off Current	$I_{CBO}$	$V_{CB}=60V$ $I_E=0$			100	μA
Emitter Cut-Off Current	$I_{EBO}$	$V_{EB}=7.0V$ $I_C=0$			100	μA
DC Current Gain	$h_{FE}$	$V_{CE}=5.0V$ $I_C=500mA$	60		200	
Collector to Emitter Saturation Voltage	$V_{CE(sat)}$	$I_C=2.0A$ $I_B=200mA$		0.25	1.0	V
Base-Emitter Voltage	$V_{BE}$	$V_{CE}=5.0V$ $I_C=500mA$		0.7	1.0	V
Transition Frequency	$f_T$	$V_{CE}=5.0V$ $I_C=500mA$		3.0		MHz
Collector output capacitance	$C_{ob}$	$V_{CB}=10V$ $I_E=0$ $f=1.0MHz$		35		pF
Turn-On Time	$t_{on}$	$I_{B1}=-I_{B2}=0.2A$		0.65		μS
Storage Time	$t_{stg}$	$I_{B1}=-I_{B2}=0.2A$		1.3		μS
Fall Time	$t_f$	$I_{B1}=-I_{B2}=0.2A$		0.65		μS

电参数曲线图 / Electrical Characteristic Curve

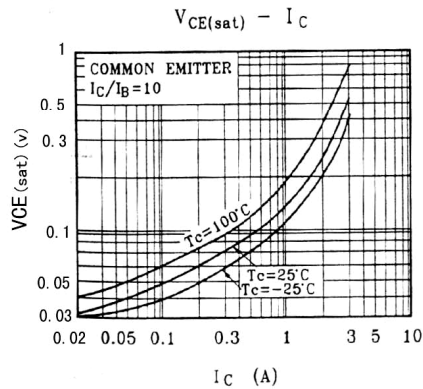
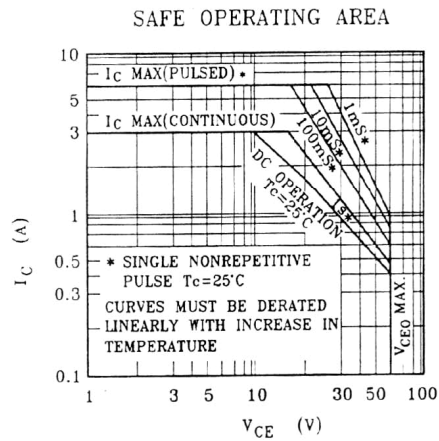
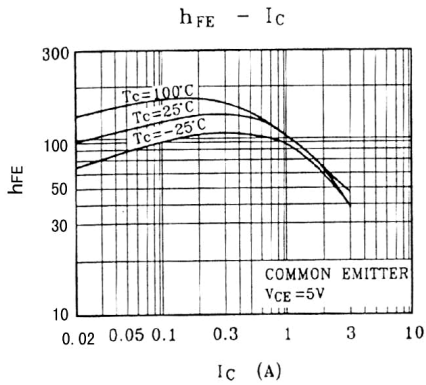
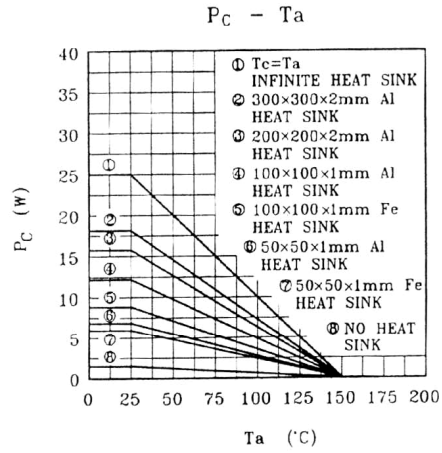
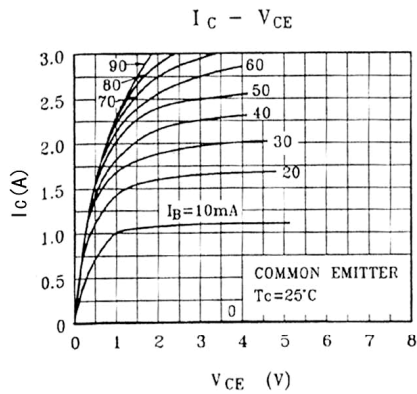

外形尺寸图 / Package Dimensions

T0-220F

单位: mm

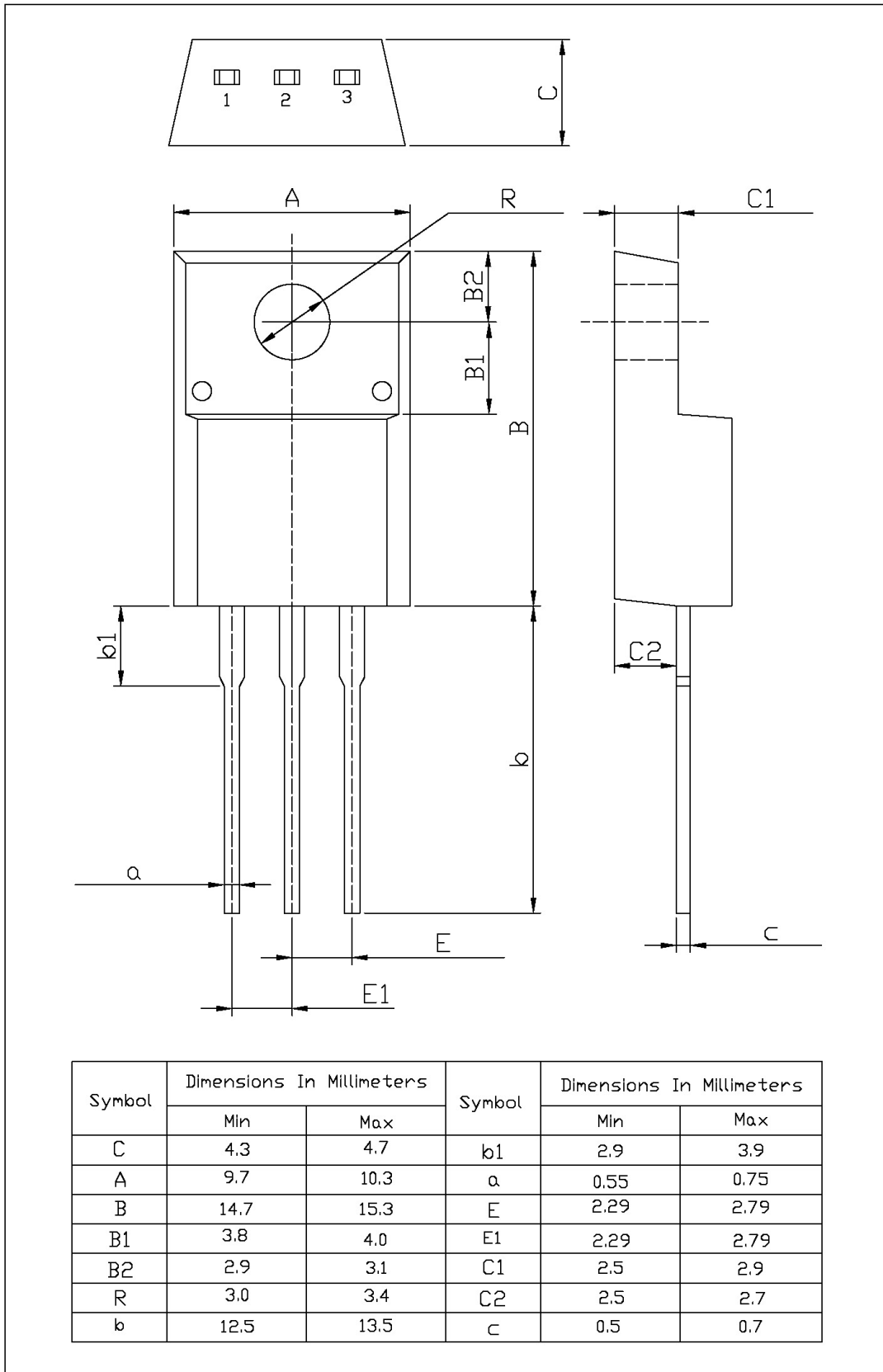

印章说明 / Marking Instructions

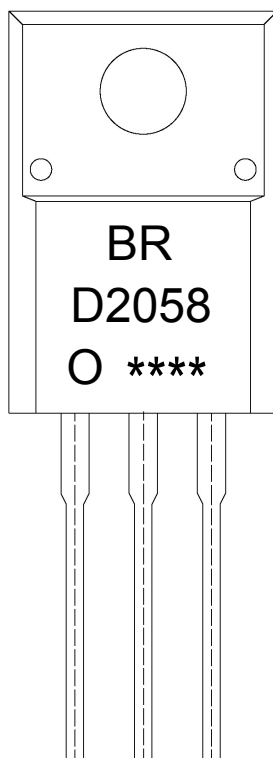

说明：

BR： 为公司代码

D2058： 为型号代码

O： 为档次代码

\*\*\*\*： 为生产批号代码，随生产批号变化。

Note:

BR: Company Code.

D2058: Product Type.

O:  $h_{FE}$  Classifications Symbol.

\*\*\*\*: Lot No. Code, code change with Lot No.

**波峰焊温度曲线图(无铅) / Temperature Profile for Dip Soldering(Pb-Free)**

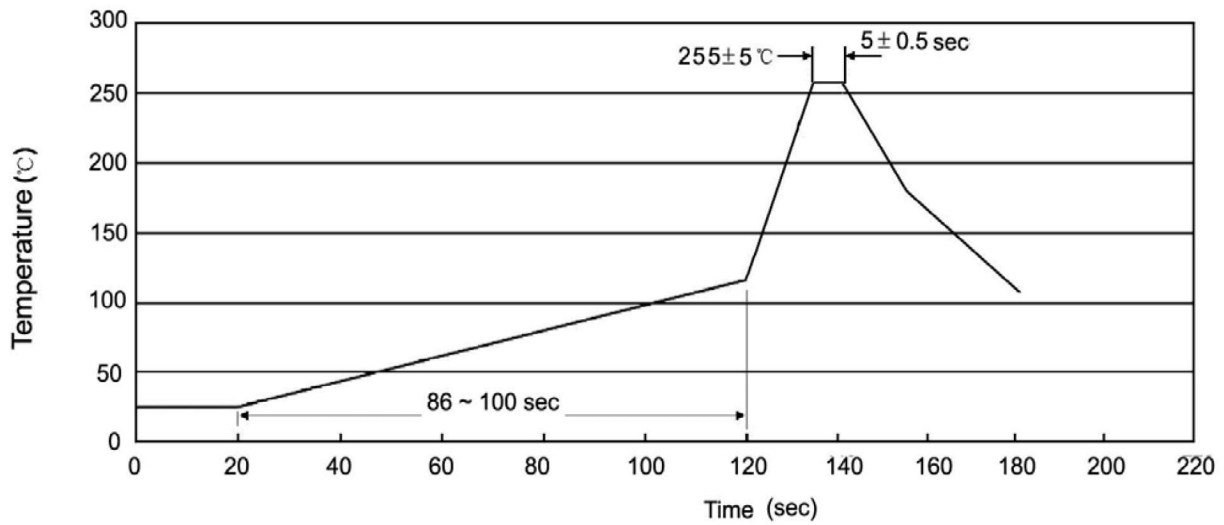

说明：

- 1、预热温度 25 ~ 150°C，时间 60 ~ 90sec；
- 2、峰值温度 255±5°C，时间持续为 5±0.5sec；
- 3、焊接制程冷却速度为 2 ~ 10°C/sec.

Note:

- 1.Preheating:25~150°C, Time:60~90sec.
- 2.Peak Temp.:255±5°C, Duration:5±0.5sec.
3. Cooling Speed: 2~10°C/sec.

**耐焊接热试验条件 / Resistance to Soldering Heat Test Conditions**

温度：270±5°C

时间：10±1 sec.

Temp:270±5°C

Time:10±1 sec

**包装规格 / Packaging SPEC.**

散件包装 / BULK

Package Type 封装形式	Units 包装数量					Dimension 包装尺寸 (unit: mm3)		
	Units/Bag 只/袋	Bags/Inner Box 袋/盒	Units/Inner Box 只/盒	Inner Boxes/Outer Box 盒/箱	Units/Outer Box 只/箱	Bag 袋	Inner Box 盒	Outer Box 箱
TO-220F	200	10	2,000	5	10,000	135×190	237×172×102	560×245×195

套管包装 / TUBE

Package Type 封装形式	Units 包装数量					Dimension 包装尺寸 (unit: mm3)		
	Units/Tube 只/套管	Tubes/Inner Box 套管/盒	Units/Inner Box 只/盒	Inner Boxes/Outer Box 盒/箱	Units/Outer Box 只/箱	Tube 套管	Inner Box 盒	Outer Box 箱
TO-220F	50	20	1,000	5	5,000	532×31.4×5.5	555×164×50	575×290×180

**使用说明 / Notices**