

描述 / Descriptions

SOT-23 塑封封装 稳压二极管。
Zener Diode in a SOT-23 Plastic Package.

特征 / Features

300mW 功耗，非常适合于自动化装配流程，无卤产品。
300mW power dissipation, Ideally Suited for Automated Assembly, HF Product.

用途 / Applications

适用于 2.4V-39V 的宽范围稳压电路。
2.4V to 39V wide zener voltage range applications.

内部等效电路 / Equivalent Circuit

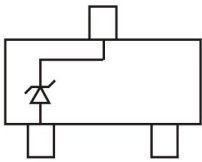

引脚排列 / Pinning

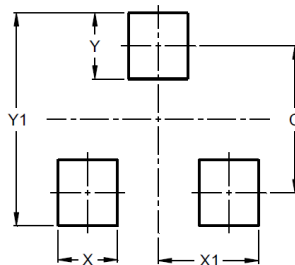
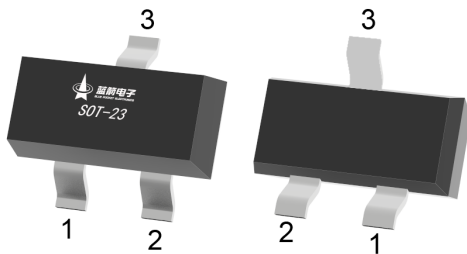

Dimensions	Value (in mm)
C	2.0
X	0.8
X1	1.35
Y	0.9
Y1	2.9

PIN: See Equivalent Circuit.

印章代码 / Marking

见电性能参数。 See Electrical Characteristics.

极限参数 / Absolute Maximum Ratings(Ta=25°C)

参数 Parameter	符号 Symbol	数值 Rating	单位 Unit
Forward Voltage(I _F =10mA)	V _F	0.9	V
Power Dissipation(Note 1)	P _D	300	mW
Power Dissipation(Note 4)	P _D	350	mW
Thermal Resistance, Junction to Ambient(Note 1)	R _{θJA}	417	°C/W
Thermal Resistance, Junction to Ambient(Note 4)	R _{θJA}	357	°C/W
Junction and Storage Temperature Range	T _j , T _{stg}	-65~150	°C

电性能参数 / Electrical Characteristics(Ta=25°C)

Type Number	Marking Code	Zener Voltage Range				Maximum Zener Impedance			Maximum Reverse Current	
		V _Z @I _{ZT}			I _{ZT}	Z _{KT} @I _{ZT}	Z _{ZK} @I _{ZK}	I _{ZK}	I _R	@V _R
		Nom (V)	Min (V)	Max (V)	mA	Ω		mA	μA	V
BZX84B2V4	HBV	2.4	2.35	2.45	5	94	564	1	45	1
BZX84B2V7	CVH	2.7	2.65	2.75	5	94	564	1	18	1
BZX84B3V0	DVH	3.0	2.94	3.06	5	89	564	1	9	1
BZX84B3V3	HEV	3.3	3.23	3.37	5	89	564	1	4.5	1
BZX84B3V6	HFV	3.6	3.53	3.67	5	84	564	1	4.5	1
BZX84B3V9	HGV	3.9	3.82	3.96	5	84	564	1	2.7	1
BZX84B4V3	HHV	4.3	4.21	4.39	5	84	564	1	2.7	1
BZX84B4V7	H1V	4.7	4.61	4.79	5	75	564	1	2.7	2
BZX84B5V1	H2V	5.1	5.00	5.20	5	56	470	1	1.8	2
BZX84B5V6	H3V	5.6	5.49	5.71	5	27	451	1	0.9	2
BZX84B6V2	H4V	6.2	6.08	6.32	5	9	376	1	2.7	4
BZX84B6V8	H5V	6.8	6.66	6.94	5	14	141	1	1.8	4
BZX84B7V5	H6V	7.5	7.35	7.65	5	14	75	1	0.9	5
BZX84B8V2	H7V	8.2	8.04	8.36	5	14	75	1	0.63	5
BZX84B9V1	H8V	9.1	8.92	9.28	5	14	94	1	0.45	6
BZX84B10	H9V	10	9.80	10.20	5	18	141	1	0.18	7
BZX84B11	H1U	11	10.78	11.22	5	18	141	1	0.09	8

电性能参数 / Electrical Characteristics(Ta=25°C)

Type Number	Marking Code	Zener Voltage Range (Note 2)				Maximum Zener Impedance (Note 3)			Maximum Reverse Current	
		V _Z @I _{ZT}			I _{ZT}	Z _{ZT} @I _{ZT}	Z _{ZK} @I _{ZK}	I _{ZK}	I _R	@V _R
		Nom (V)	Min (V)	Max (V)	mA	Ω		mA	uA	V
BZX84B12	H2U	12	11.76	12.24	5	23	141	1	0.09	8
BZX84B13	H3U	13	12.74	13.26	5	28	160	1	0.045	8
BZX84B15	H4U	15	14.70	15.30	5	28	188	1	0.045	10.5
BZX84B16	H5U	16	15.68	16.32	5	37	188	1	0.045	11.2
BZX84B18	H6U	18	17.64	18.36	5	42	212	1	0.045	12.6
BZX84B20	H7U	20	19.60	20.40	5	51	212	1	0.045	14.0
BZX84B22	H8U	22	21.56	22.44	5	51	235	1	0.045	15.4
BZX84B24	H9U	24	23.52	24.48	5	65	235	1	0.045	16.8
BZX84B27	HAU	27	26.46	27.54	5	75	282	0.5	0.045	18.9
BZX84B30	HBU	30	29.40	30.60	5	75	282	0.5	0.045	21.0
BZX84B33	CUH	33	32.34	33.66	5	75	306	0.5	0.045	23.0
BZX84B36	DUH	36	35.28	36.72	5	84	329	0.5	0.045	25.2
BZX84B39	HEU	39	38.22	39.78	5	122	329	0.5	0.045	27.3

Notes:

1. Device mounted on FR-4 PC board with recommended pad layout.
2. Short duration test pulse used to minimize self-heating effect.
3. f = 1KHz.
4. Valid provided the terminals are kept at ambient temperature.

电参数曲线图 / Electrical Characteristic Curve

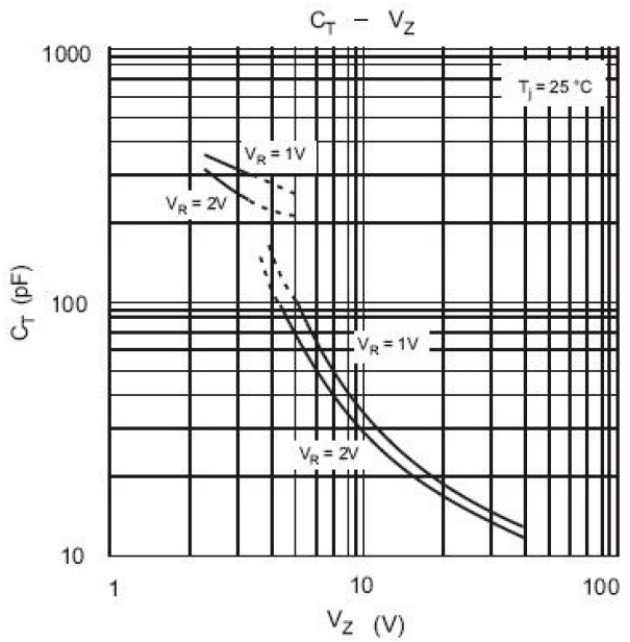
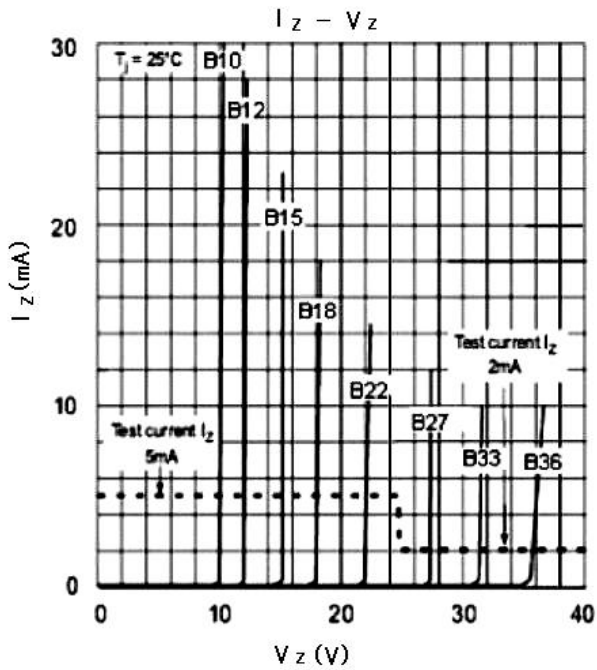
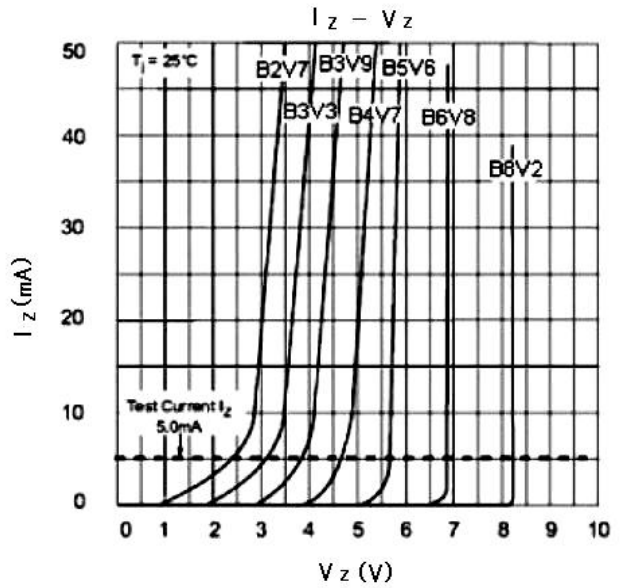
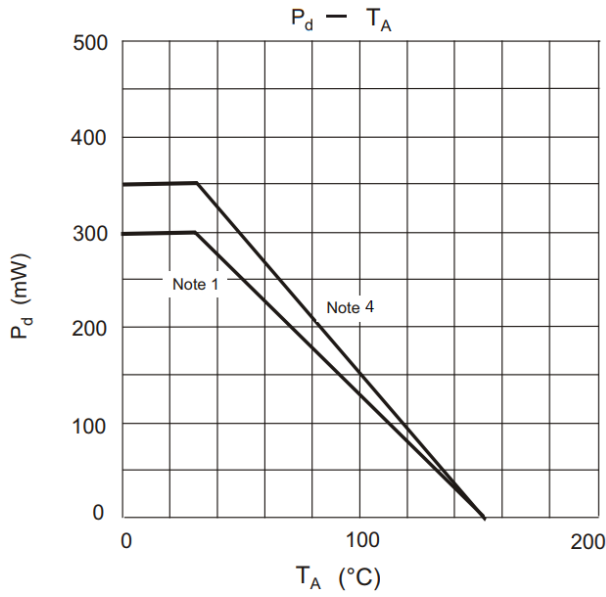

外形尺寸图 / Package Dimensions

SOT-23

单位: mm

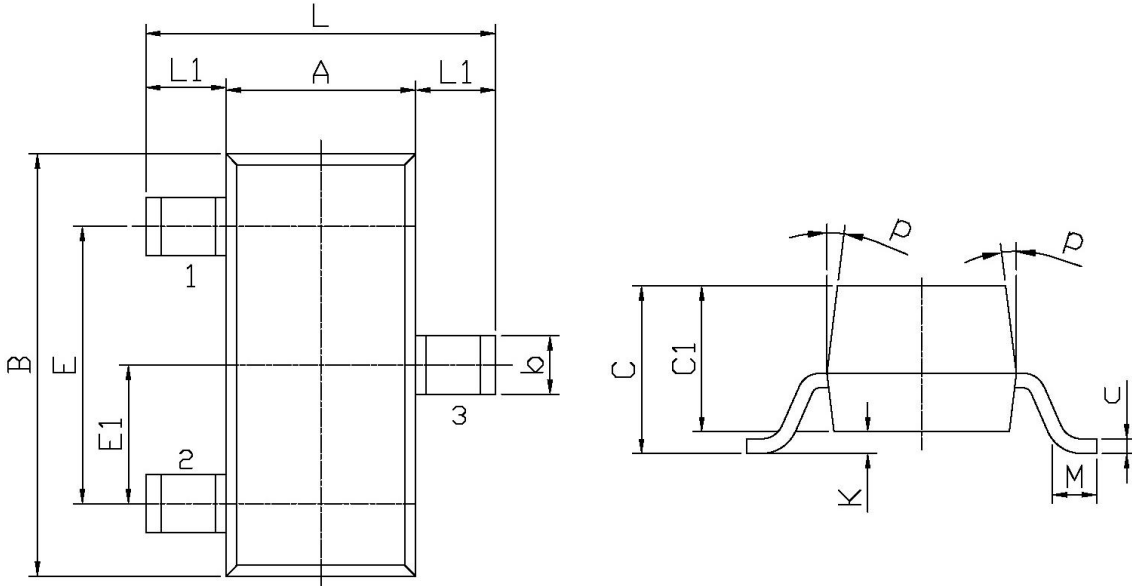

Symbol	Dimensions In Millimeters		Symbol	Dimensions In Millimeters	
	Min	Max		Min	Max
L	2.2	2.7	C	1.30Max	
L1	0.45	0.65	C1	0.90	1.20
A	1.15	1.50	c	0.05	0.20
B	2.70	3.10	K	0	0.10
E	1.70	2.10	M	0.20MIN	
E1	0.85	1.05	P	7°	
b	0.35	0.55			

印章说明 / Marking Instructions

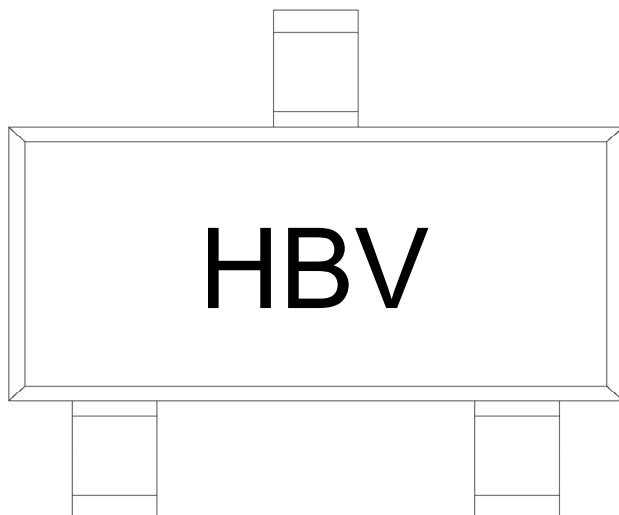

说明：

H： 为公司代码

BV： 为型号代码

Note:

H: Company Code

BV: Product Type

回流焊温度曲线图(无铅) / Temperature Profile for IR Reflow Soldering(Pb-Free)

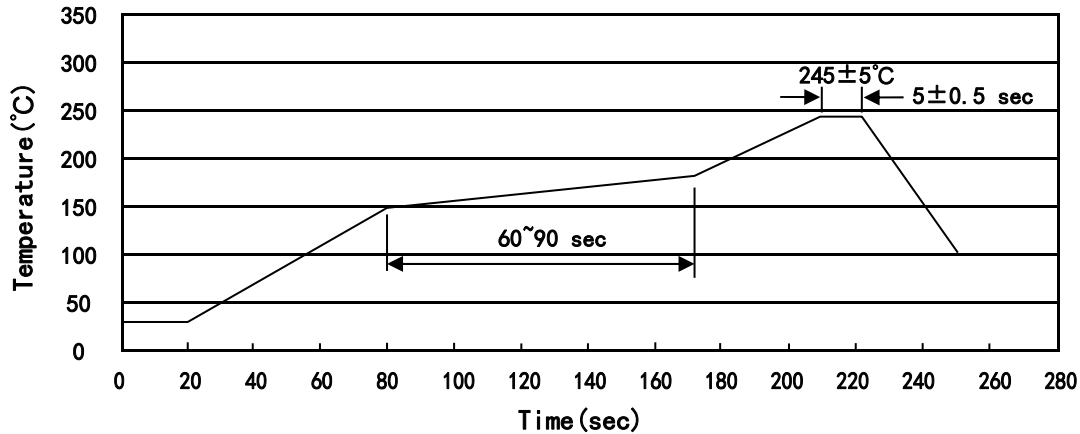

说明：

- 1、预热温度 150 ~ 180°C，时间 60 ~ 90sec;
- 2、峰值温度 245±5°C，时间持续为 5±0.5sec;
- 3、焊接制程冷却速度为 2 ~ 10°C/sec.

Note:

- 1.Preheating:150~180°C, Time:60~90sec.
- 2.Peak Temp.:245±5°C, Duration:5±0.5sec.
3. Cooling Speed: 2~10°C/sec.

耐焊接热试验条件 / Resistance to Soldering Heat Test Conditions

温度：260±5°C 时间：10±1 sec. Temp.:260±5°C Time:10±1 sec

包装规格 / Packaging SPEC.

卷盘包装 / REEL

Package Type 封装形式	Units 包装数量					Dimension 包装尺寸 (unit: mm ³)		
	Units/Reel 只/卷盘	Reels/Inner Box 卷盘/盒	Units/Inner Box 只/盒	Inner Boxes/Outer Box 盒/箱	Units/Outer Box 只/箱	Reel	Inner Box 盒	Outer Box 箱
SOT-23	3,000	10	30,000	6	180,000	7" ×8	180×120×180	390×385×205

使用说明 / Notices