

BRMUR1040CTBD

Rev.B .Mar.-2019

描述 / Descriptions

TO-263 塑封封装 超快恢复二极管。

Ultrafast Recovery Diode in a TO-263 Plastic Package.

特征 / Features

采用硅外延工艺生产的超快恢复二极管，具有较低的反向漏电和高可靠性。

Silicon epitaxial process to produce ultrafast recovery diode with low reverse leakage current and high reliability.

用途 / Applications

用于高频、高压、大电流整流二极管，续流二极管，PFC 电路。

For high frequency, high voltage, high current rectifier diode, freewheeling diode, PFC circuit.

内部等效电路 / Equivalent Circuit

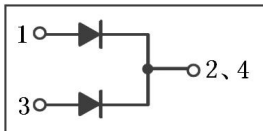

引脚排列 / Pinning



PIN1 : Anode

PIN 2、 4 : Cathode

PIN 3 : Anode

放大及印章代码 / h_{FE} Classifications & Marking

见印章说明。See Marking Instructions.

极限参数 / Absolute Maximum Ratings(Ta=25°C)

参数 Parameter	符号 Symbol	数值 Rating	单位 Unit
Peak Repetitive Reverse Voltage	V_{RRM}	400	V
RMS Voltage	V_{RMS}	280	V
DC Blocking Voltage	V_{DC}	400	V
Peak Repetitive Forward Current	I_F	10	A
Non Repetitive Peak Surge Current	I_{FSM}	100	A
Maximum Thermal Resistance Junction to Case	$R_{\theta Jc}$	2.8	°C/W
Storage Temperature Range	T_{stg}	-55~150	°C

电性能参数 / Electrical Characteristics(Ta=25°C)

参数 Parameter	符号 Symbol	测试条件 Test Conditions	数值 Rating	单位 Unit
Forward Voltage	V_F	$I_F=5A$ $T_c=25^\circ C$	1.3	V
Instantaneous Reverse Current	I_R	$V_R=400V$ $T_a=25^\circ C$	10	μA
		$V_R=400V$ $T_a=125^\circ C$	250	μA
Reverse Recovery Time	t_{rr}	$I_F=0.5A$ $I_R=1.0A$ $I_{REC}=0.25A$	50	ns



电参数曲线图 / Electrical Characteristic Curve

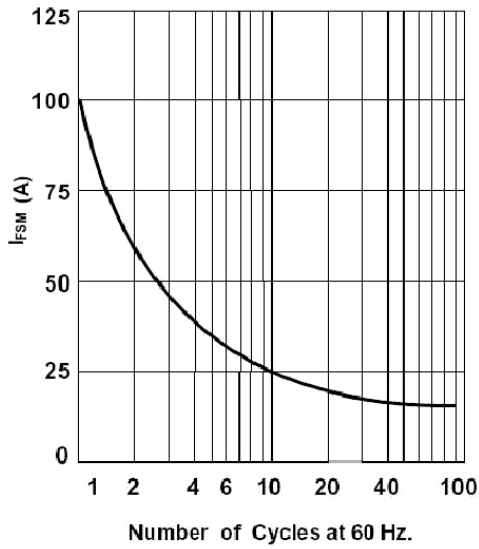
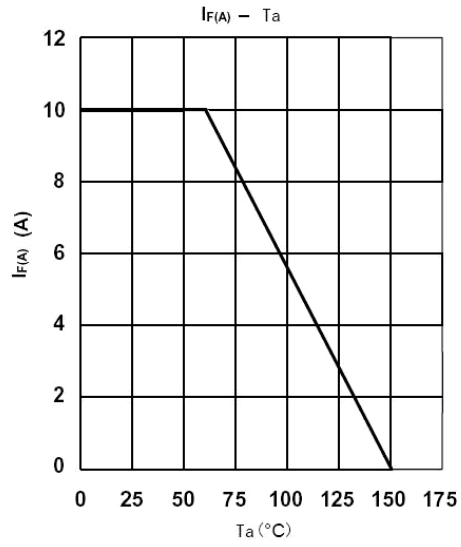
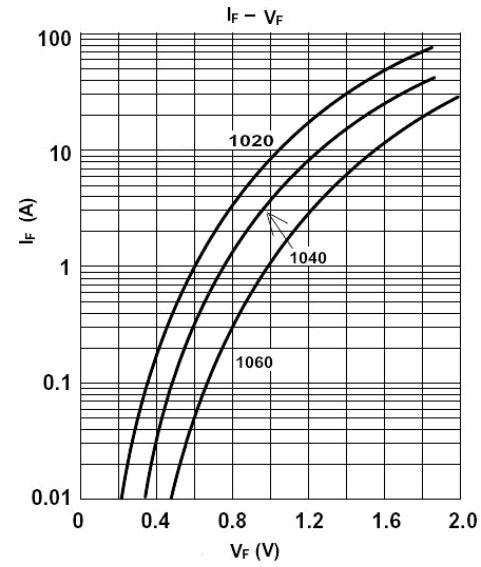

外形尺寸图 / Package Dimensions

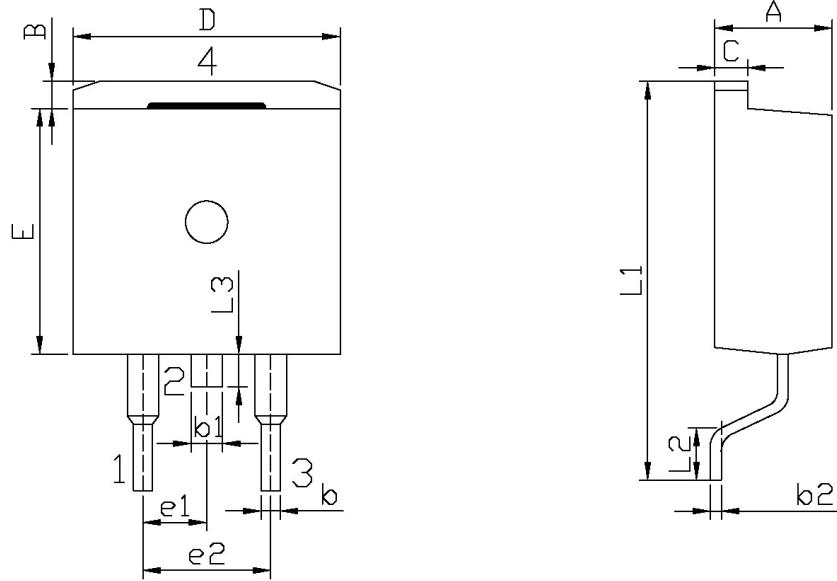

单位: mm

Symbol	Dimensions In Millimeters		Symbol	Dimensions In Millimeters	
	Min	Max		Min	Max
A	4.30	4.70	E	9.00	9.40
B	1.00	1.40	e1	2.34	2.74
b	0.70	0.90	e2	4.88	5.28
b1	1.15	1.35	L1	15.00	16.00
b2	0.40	0.60	L2	2.24	2.84
C	1.20	1.40	L3	1.20	1.60
D	9.80	10.20			

TO-263

印章说明 / Marking Instructions

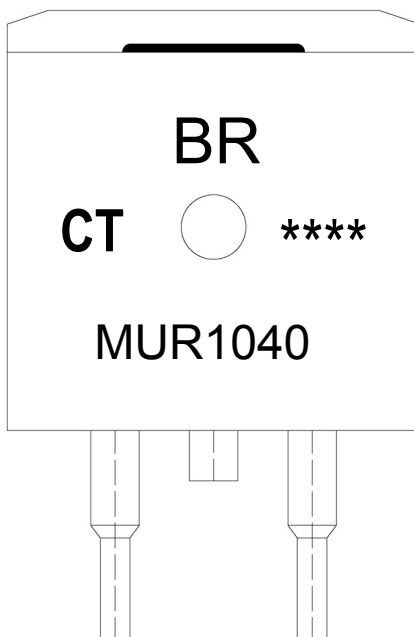

说明：

BR： 为公司代码

MUR1040： 为产品型号

CT: 为内部结构

****： 为生产批号代码，随生产批号变化。

Note:

BR: Company Code

MUR1040: Product Type

CT: Internal Structure

****: Lot No. Code, code change with Lot No.

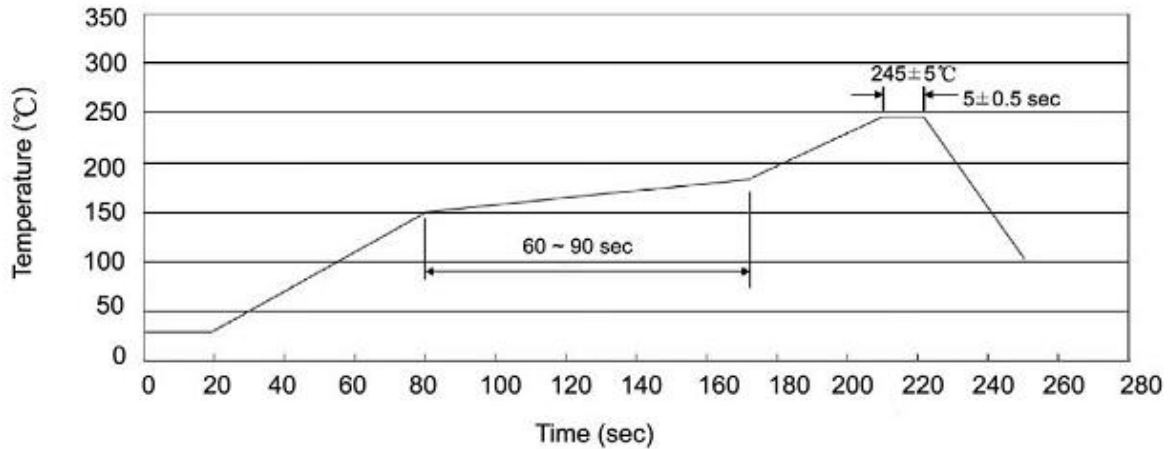
回流焊温度曲线图(无铅) / Temperature Profile for IR Reflow Soldering(Pb-Free)

说明：

- 1、预热温度 150~180°C，时间 60~90sec;
- 2、峰值温度 255±5°C，时间持续为 5±0.5sec;
- 3、焊接制程冷却速度为 2~10°C/sec.

Note:

- 1.Preheating:150~180°C, Time:60~90sec.
- 2.Peak Temp.:255±5°C, Duration:5±0.5sec.
3. Cooling Speed: 2~10°C/sec.

耐焊接热试验条件 / Resistance to Soldering Heat Test Conditions

温度：260±5°C

时间：10±1 sec.

Temp.:260±5°C

Time:10±1 sec

包装规格 / Packaging SPEC.

卷盘包装 / REEL

Package Type 封装形式	Units 包装数量					Dimension 包装尺寸 (unit: mm ³)		
	Units/Reel 只/卷盘	Reels/Inner Box 卷盘/盒	Units/Inner Box 只/盒	Inner Boxes/Outer Box 盒/箱	Units/Outer Box 只/箱	Reel	Inner Box 盒	Outer Box 箱
TO-263	800	1	800	5	4,000	13" ×24	360×360×50	385×257×392

套管包装 / TUBE

Package Type 封装形式	Units 包装数量					Dimension 包装尺寸 (unit: mm ³)		
	Units/Tube 只/套管	Tubes/Inner Box 套管/盒	Units/Inner Box 只/盒	Inner Boxes/Outer Box 盒/箱	Units/Outer Box 只/箱	Tube 套管	Inner Box 盒	Outer Box 箱
TO-263	50	20	1,000	5	5,000	532×33×7.0	555×164×50	575×290×180

使用说明 / Notices