

描述 / Descriptions

TO-252 塑封封装 NPN 半导体三极管。

Silicon NPN transistor in a TO-252 Plastic Package.

特征 / Features

直流电流增益高，E 与 C 间内置阻尼二极管电性能与 BRTIP112Q 等同，符合 AEC-Q101 标准高可靠性要求，无卤产品。

High DC current gain, built-in a damper diode at E-C, electrically similar to popular BRTIP112Q, Qualified to AEC-Q101 Standards for High Reliability, HF Product.

用途 / Applications

用于中功率放大或开关电路，满足汽车应用的严格要求。

Medium power switching applications, Meet the stringent requirements of automotive applications.

内部等效电路 / Equivalent Circuit

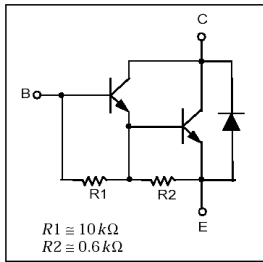

引脚排列 / Pinning

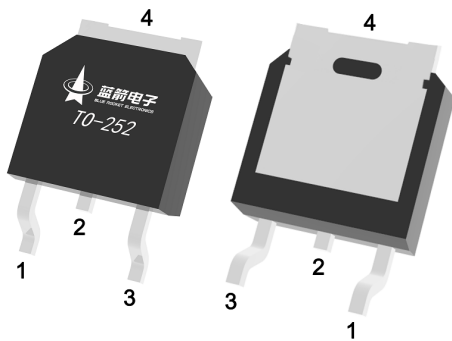

PIN1 : Base

PIN 2,4 : Collector

PIN 3 : Emitter

放大及印章代码 / hFE Classifications & Marking

见印章说明。

See Marking Instructions.

极限参数 / Absolute Maximum Ratings(Ta=25°C)

参数 Parameter	符号 Symbol	数值 Rating	单位 Unit
Collector to Base Voltage	V _{CBO}	100	V
Collector to Emitter Voltage	V _{CEO}	100	V
Emitter to Base Voltage	V _{EBO}	5.0	V
Collector Current - Continuous	I _C	2.0	A
Collector Current – Continuous(Pulse)	I _{C(Pulse)}	4.0	A
Base Current - Continuous	I _B	50	mA
Collector Power Dissipation	P _C	1.75	W
Collector Power Dissipation	P _{C(T_C=25°C)}	20	W
Junction Temperature	T _j	150	°C
Storage Temperature Range	T _{stg}	-55~150	°C

Pulse Test:PW≤300μs,Duty Cycle≤2%

电性能参数 / Electrical Characteristics(Ta=25°C)

参数 Parameter	符号 Symbol	测试条件 Test Conditions	最小值 Min	典型值 Typ	最大值 Max	单位 Unit
Collector to Emitter Breakdown Voltage*	V _{CEO} *	I _C =10mA I _B =0	100			V
Collector Cut-Off Current	I _{CEO}	V _{CE} =50V I _B =0			0.02	mA
Collector Cut-Off Current	I _{CBO}	V _{CB} =100V I _E =0			0.02	mA
Emitter Cut-Off Current	I _{EBO}	V _{EB} =5.0V I _C =0			2.0	mA
DC Current Gain	h _{FE(1)} *	V _{CE} =3.0V I _C =2.0A	1000		12K	
	h _{FE(2)} *	V _{CE} =3.0V I _C =0.5A	500			
	h _{FE(3)} *	V _{CE} =3.0V I _C =4.0A	200			
Collector-Emitter Saturation Voltage	V _{CE(sat)1} *	I _C =2.0A I _B =8.0mA			2.0	V
	V _{CE(sat)2} *	I _C =4.0A I _B =40mA			3.0	V
Base-Emitter Saturation Voltage*	V _{BE(sat)} *	I _C =4.0A I _B =40mA			4.0	V
Base-Emitter-On Voltage*	V _{BE(on)} *	V _{CE} =3.0V I _C =2.0A			2.8	V
Current Gain Bandwidth Product	f _T	V _{CE} =10V I _C =0.75A	25			MHz
Output Capacitance	C _{ob}	V _{CB} =10V I _E =0 f=0.1MHz			100	pF

*Pulse Test:Pulse Width≤380us,Duty Cycle≤2%. *脉冲测试：脉宽≤380us,占空比≤2%。

电参数曲线图 / Electrical Characteristic Curve

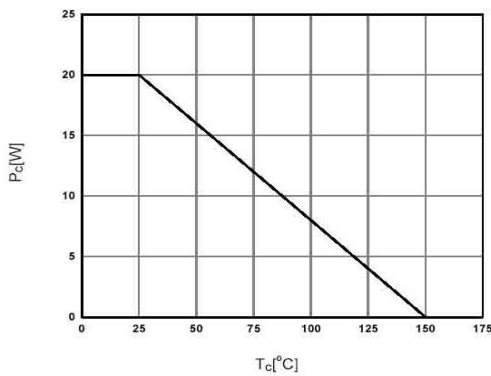
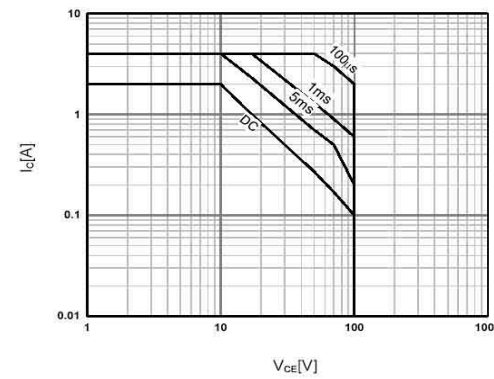
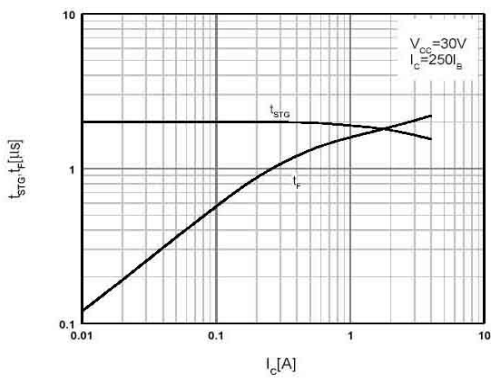
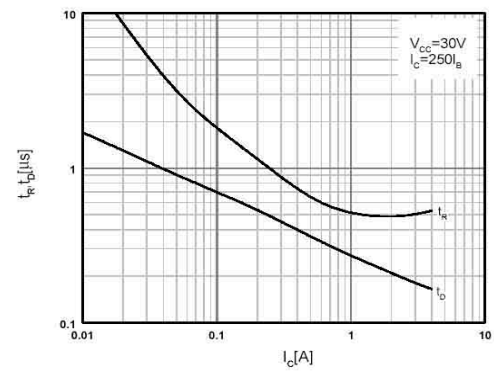
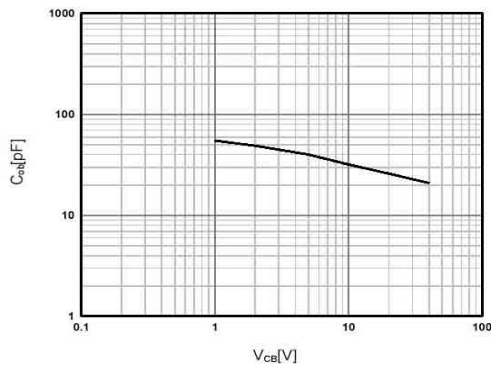
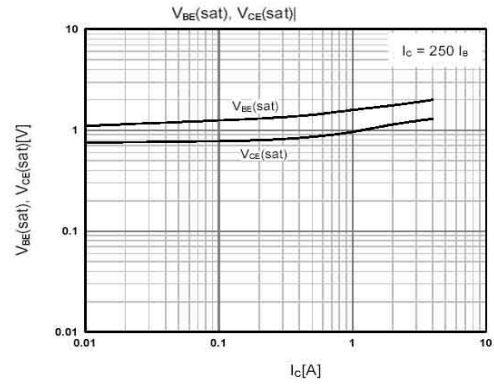
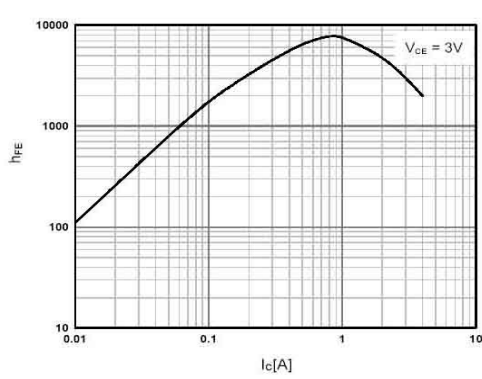

外形尺寸图 / Package Dimensions

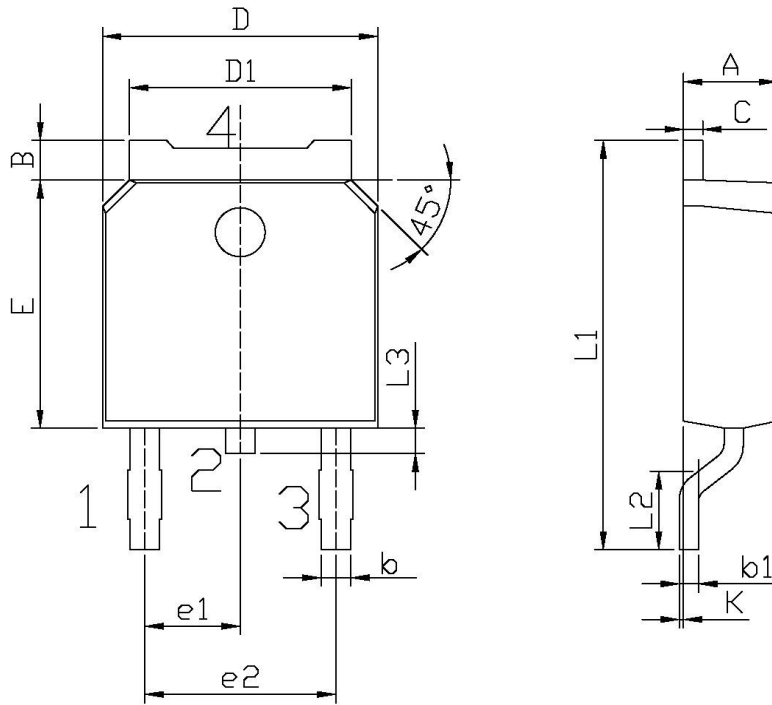

单位: mm

Symbol	Dimensions In Millimeters		Symbol	Dimensions In Millimeters	
	Min	Max		Min	Max
A	2.20	2.40	E	5.95	6.25
B	0.95	1.25	e1	2.24	2.34
b	0.70	0.90	e2	4.43	4.73
b1	0.45	0.55	L1	9.85	10.35
C	0.45	0.55	L2	1.70	2.00
D	6.45	6.75	L3	0.60	0.90
D1	5.10	5.50	K	0.00	0.10

TO-252

印章说明 / Marking Instructions

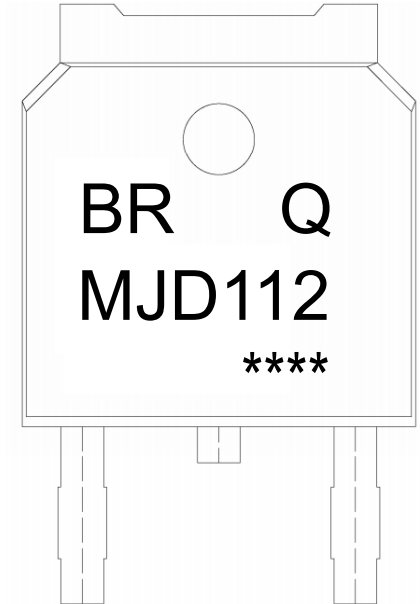

说明：

BR： 为公司代码

Q： 为汽车无卤产品标识

MJD112： 为产品型号

****： 为生产批号代码，随生产批号变化

Note:

BR: Company Code

Q: Automobile halogen-free product Code

MJD112: Product Type

****: Lot No. Code, code change with Lot No

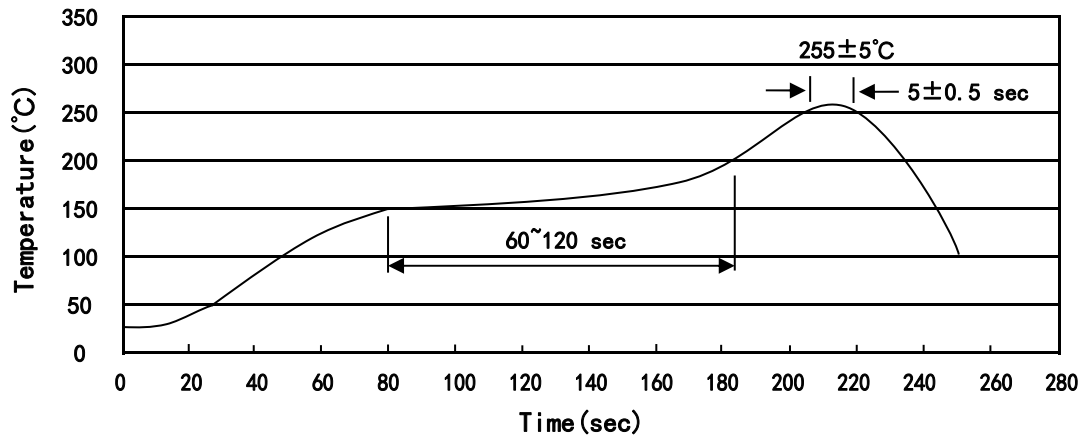
回流焊温度曲线图(无铅) / Temperature Profile for IR Reflow Soldering(Pb-Free)

说明：

- 1、预热温度 150~200°C，时间 60~120sec;
- 2、峰值温度 255±5°C，时间持续为 5±0.5sec;
- 3、焊接制程冷却速度为 2~10°C/sec.

Note:

- 1.Preheating:150~200°C, Time:60~120sec.
- 2.Peak Temp.:255±5°C, Duration:5±0.5sec.
3. Cooling Speed: 2~10°C/sec.

耐焊接热试验条件 / Resistance to Soldering Heat Test Conditions

温度：260±5°C

时间：10±1 sec.

Temp.:260±5°C

Time:10±1 sec

包装规格 / Packaging SPEC.

卷盘包装 / REEL

Package Type 封装形式	Units 包装数量					Dimension 包装尺寸 (unit: mm ³)		
	Units/Reel 只/卷盘	Reels/Inner Box 卷盘/盒	Units/Inner Box 只/盒	Inner Boxes/Outer Box 盒/箱	Units/Outer Box 只/箱	Reel	Inner Box 盒	Outer Box 箱
TO-252	2,500	2	5,000	6	30,000	13" ×16	360×360×50	380×335×366

套管包装 / TUBE

Package Type 封装形式	Units 包装数量					Dimension 包装尺寸 (unit: mm ³)		
	Units/Tube 只/套管	Tubes/Inner Box 套管/盒	Units/Inner Box 只/盒	Inner Boxes/Outer Box 盒/箱	Units/Outer Box 只/箱	Tube 套管	Inner Box 盒	Outer Box 箱
TO-251/252	75	48	3,600	5	18,000	526×20.5×5.25	555×164×50	575×290×180

使用说明 / Notices