

BRFL70R600C

Rev.A Jan.-2024

描述 / Descriptions

TO-220FL 塑封封装 N 沟道 700V 超结工艺功率场效应管。

N-CHANNEL 700V Super-Junction Power MOSFET in a TO-220FL Plastic Package.

特征 / Features

低 $R_{DS(on)} \times Q_g$, 100%雪崩测试, 符合 RoHS 标准, 无卤产品。

Very low $R_{DS(on)} \times Q_g$, 100% avalanche tested, RoHS compliant, HF product.

用途 / Applications

用于开关电源, 不间断电源, 功率因素校正。

For switch mode power supply, uninterruptible power supply, power factor correction.

内部等效电路 / Equivalent Circuit

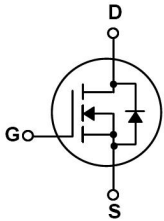

引脚排列 / Pinning

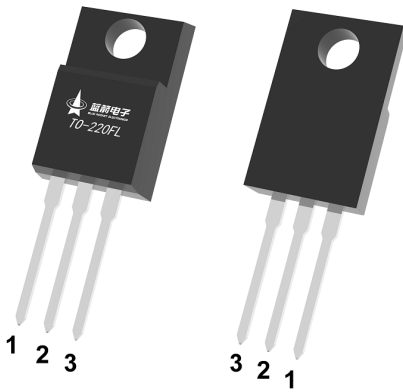

PIN1 : G

PIN 2 : D

PIN 3 : S

印章代码 / Marking

见印章说明。

See Marking Instructions.

极限参数 / Absolute Maximum Ratings(Ta=25°C)

参数 Parameter	符号 Symbol	数值 Rating	单位 Unit
Drain-Source Voltage	V_{DS}	700	V
Drain Current	$I_D(T_C=25^\circ\text{C})$	7	A
Drain Current - Pulsed	I_{DM}	28	A
Gate-Source Voltage	V_{GS}	± 30	V
Single Pulsed Avalanche Energy	E_{AS}	200	mJ
Avalanche Current	I_{AS}	6.1	A
Power Dissipation	$P_D(T_C=25^\circ\text{C})$	31	W
Operating and Storage Temperature Range	T_J, T_{STG}	-55 to 150	$^\circ\text{C}$
Junction-to-Case	$R_{\theta JC}$	4	$^\circ\text{C/W}$
Junction-to-Ambient	$R_{\theta JA}$	62.5	$^\circ\text{C/W}$

电性能参数 / Electrical Characteristics(Ta=25°C)

参数 Parameter	符号 Symbol	测试条件 Test Conditions	最小值 Min	典型值 Typ	最大值 Max	单位 Unit
Drain-Source Breakdown Voltage	BV_{DSS}	$V_{GS}=0V$ $I_D=250\mu A$	700	745		V
Zero Gate Voltage Drain Current	I_{DSS}	$V_{DS}=700V$ $V_{GS}=0V$ $T_J=25^\circ\text{C}$			1.0	μA
Gate-Body Leakage Current, Forward	I_{GSS}	$V_{GS}=\pm 30V$			± 100	nA
Gate Threshold Voltage	$V_{GS(th)}$	$V_{DS}=V_{GS}$ $I_D=250\mu A$	2.5	3.4	4.5	V
Static Drain-Source On-Resistance	$R_{DS(on)}$	$V_{GS}=10V$ $I_D=3.5A$		495	600	m Ω
Drain-Source Diode Forward Voltage	V_{SD}	$V_{GS}=0V$ $I_{SD}=7A$ $T_J=25^\circ\text{C}$			1.2	V
Gate Resistance	R_g	$V_{GS}=0V$ $f=1.0\text{MHz}$		8.8		Ω
Input Capacitance	C_{iss}	$V_{DS}=100V$ $V_{GS}=0V$ $f=1.0\text{MHz}$		694		pF
Output Capacitance	C_{oss}			30		pF
Reverse Transfer Capacitance	C_{rss}			0.6		pF
Turn-On Delay Time	$t_{d(on)}$	$V_{DS}=350V$ $I_D=7.0A$ $V_{GS}=10V$ $R_G=25\Omega$		18.1		ns
Turn-On Rise Time	t_r			32		ns
Turn-Off Delay Time	$t_{d(off)}$			37.5		ns
Turn-Off Fall Time	t_f			24.3		ns

电性能参数 / Electrical Characteristics(Ta=25°C)

参数 Parameter	符号 Symbol	测试条件 Test Conditions	最小值 Min	典型值 Typ	最大值 Max	单位 Unit
Continuous Diode Forward Current	I _s				7	A
Total Gate Charge	Q _g	V _{DS} =560V I _D =7.0A V _{GS} =10V		17		nC
Gate-Source Charge	Q _{gs}			6.5		nC
Gate-Drain Charge	Q _{gd}			7		nC
Reverse recovery time	T _{rr}	V _R =50 V, I _F =7.0A, dI _F /dt=100 A/μs		250		ns
Reverse recovery charge	Q _{rr}			2.8		uC

电参数曲线图 / Electrical Characteristic Curve

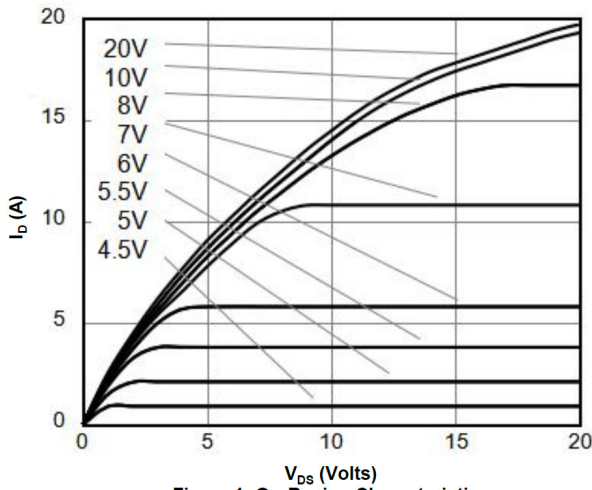

Figure 1: On-Region Characteristics

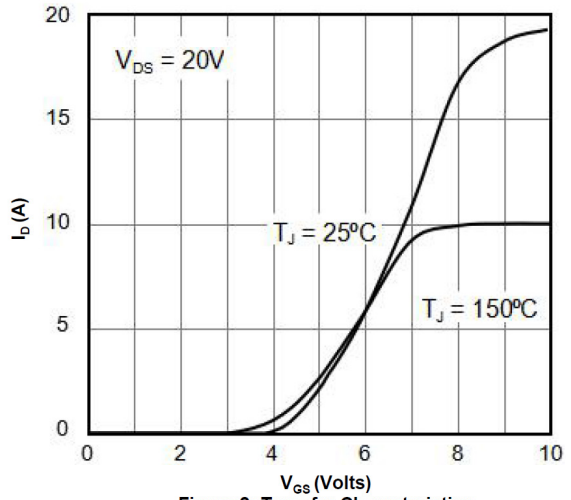

Figure 2: Transfer Characteristics

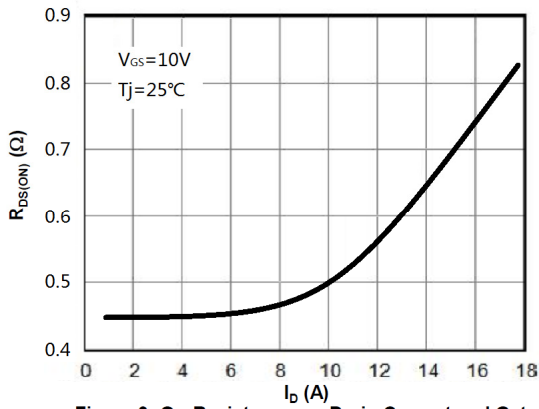

Figure 3: On-Resistance vs. Drain Current and Gate Voltage

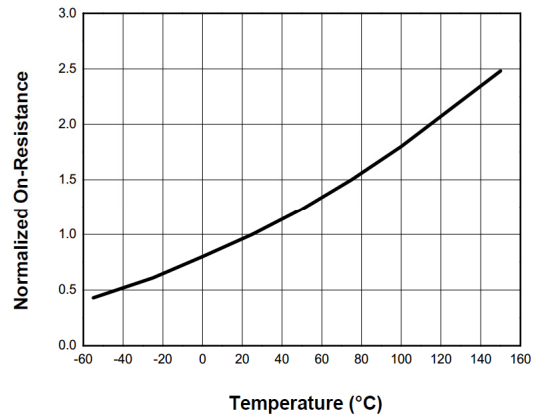

Figure 4: On-Resistance vs. Junction Temperature

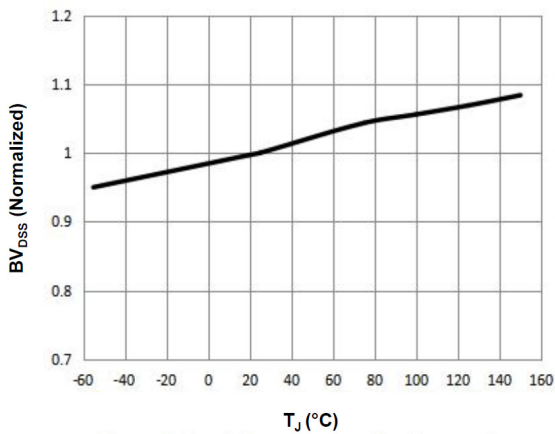

Figure 5: Break Down vs. Junction Temperature

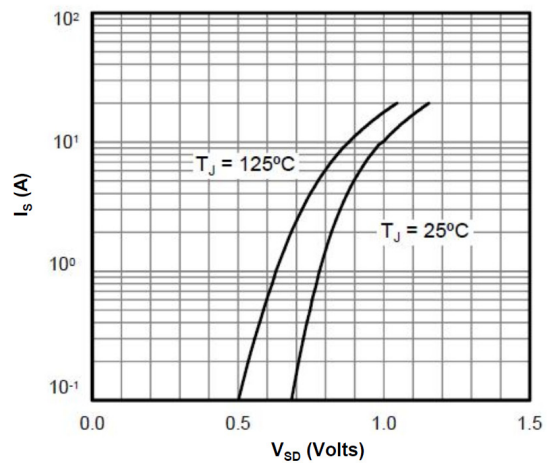

Figure 6: Body-Diode Characteristics

电参数曲线图 / Electrical Characteristic Curve

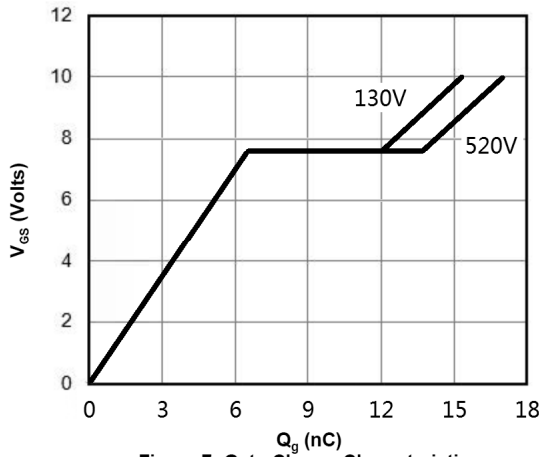

Figure 7: Gate-Charge Characteristics

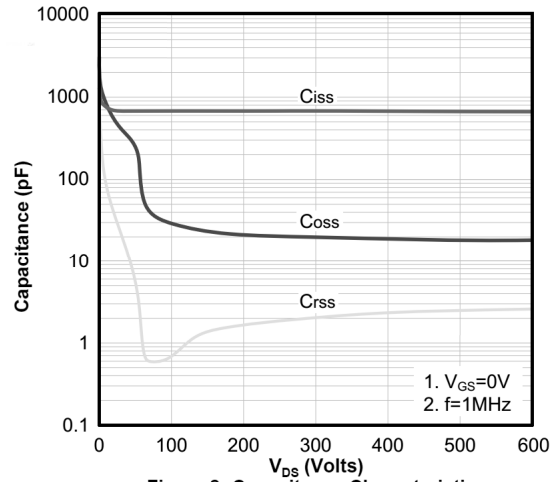

Figure 8: Capacitance Characteristics

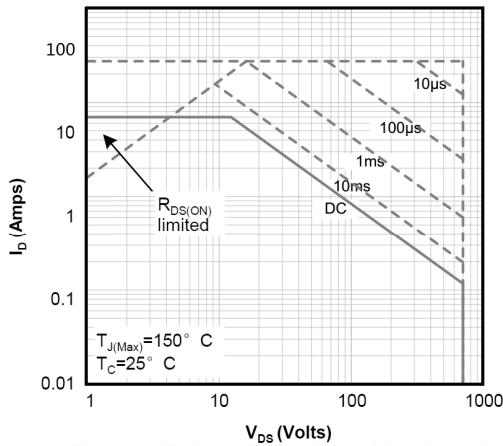

Figure 9 : Maximum Forward Biased Safe Operating Area

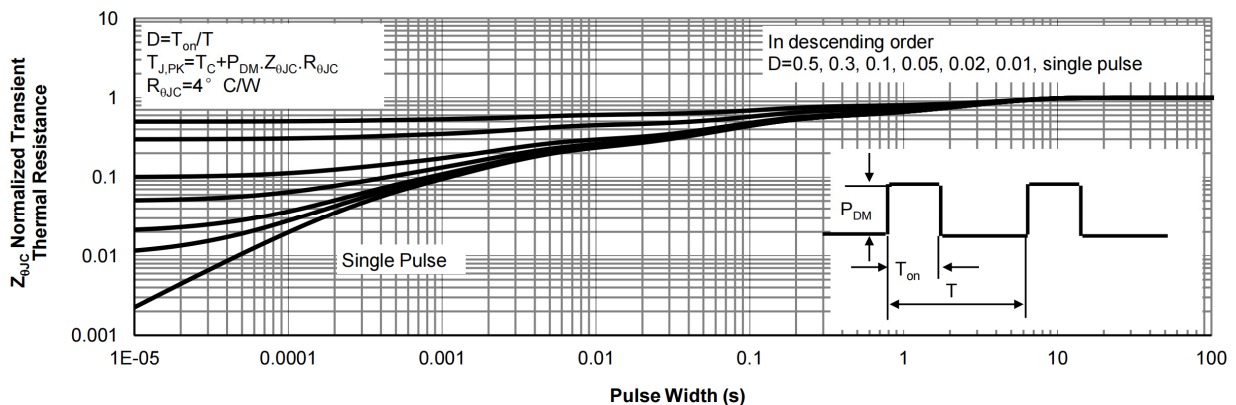
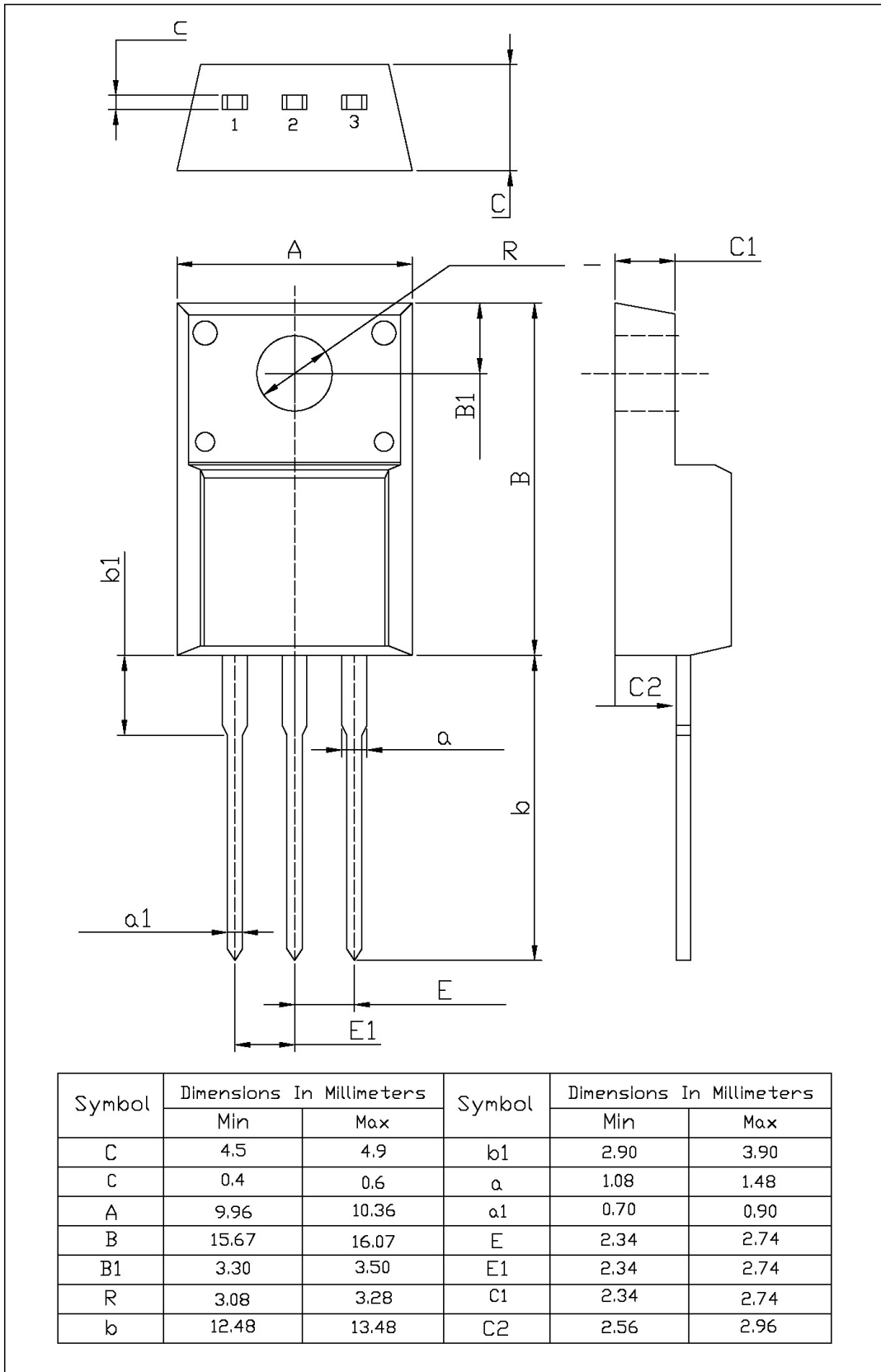

Figure 10: Normalized Maximum Transient Thermal Impedance

外形尺寸图 / Package Dimensions

TO-220FL

单位: mm



印章说明 / Marking Instructions

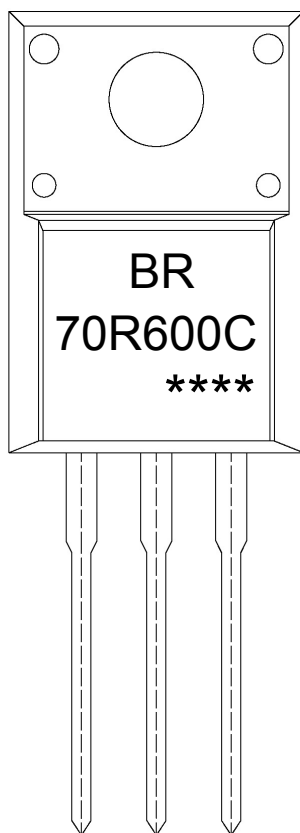

说明：

BR： 为公司代码

70R600C： 为型号代码

****： 为生产批号代码，随生产批号变化

Note:

BR: Company Code

70R600C: Product Type Code

****: Lot No. Code, code change with Lot No

波峰焊温度曲线图(无铅) / Temperature Profile for Dip Soldering(Pb-Free)

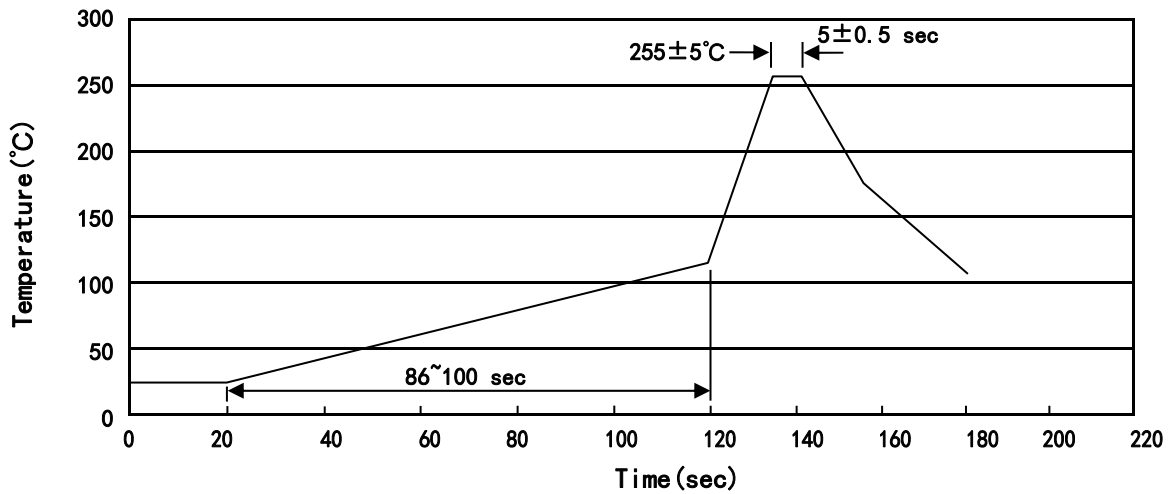

说明：

- 1、预热温度 25~150°C，时间 60~90sec;
- 2、峰值温度 255±5°C，时间持续为 5±0.5sec;
- 3、焊接制程冷却速度为 2~10°C/sec.

Note:

- 1.Preheating:25~150°C, Time:60~90sec.
- 2.Peak Temp.:255±5°C, Duration:5±0.5sec.
3. Cooling Speed: 2~10°C/sec.

耐焊接热试验条件 / Resistance to Soldering Heat Test Conditions

温度：270±5°C

时间：10±1 sec.

Temp.:270±5°C

Time:10±1 sec

包装规格 / Packaging SPEC.

套管包装 / TUBE

Package Type 封装形式	Units 包装数量					Dimension 包装尺寸 (unit: mm ³)		
	Units/Tube 只/套管	Tubes/Inner Box 套管/盒	Units/Inner Box 只/盒	Inner Boxes/Outer Box 盒/箱	Units/Outer Box 只/箱	Tube 套管	Inner Box 盒	Outer Box 箱
TO-220FL	50	20	1,000	5	5,000	532×33×7.0	555×164×50	575×290×180

使用说明 / Notices