

描述 / Descriptions

SOT-89 塑封封装低压差线性稳压器。

Low dropout linear regulator in a SOT-89 Plastic Package .

特征 / Features

低功耗，低压差，温度漂移系数小，输入电压可达 24V，静态电流 1.5 μ A，输出电压精度： $\pm 2\%$ ，无鹵产品。

Low power consumption, Low voltage drop, Small temperature drift coefficient, Input voltage up to 24V, The static current 1.5 μ A, The output voltage accuracy: $\pm 2\%$, HF Product.

用途 / Applications

用于各类电源设备，通信设备，音频和视频设备。

For use in power equipment, Communication equipment, Audio and video equipment.

内部等效电路 / Equivalent Circuit

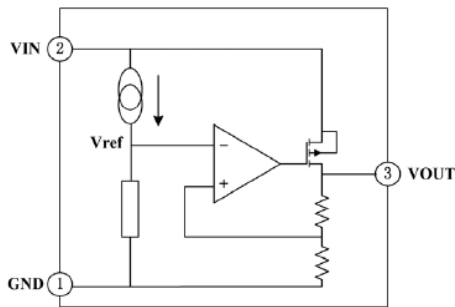

引脚排列 / Pinning

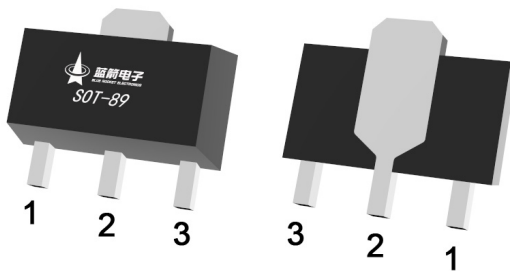

PIN1 : GND

PIN 2 : VIN

PIN 3 : VOUT

印章代码 / Marking

见印章说明。

See Marking Instructions.

极限参数 / Absolute Maximum Ratings(Ta=25°C)

参数 Parameter	符号 Symbol	数值 Rating	单位 Unit
Working Voltage	V _{IN}	-0.3~26	V
Thermal Resistance	R _{θJA}	200	°C/W
Power Consumption	P _D	500	mW
Storage Temperature	T _{STG}	-50~+125	°C
Working Temperature	T _A	-40~+85	°C

注：如果器件运行条件超过上述各项条件最大额定值，可能对器件造成永久性损坏。上述参数仅是运行条件的极大值，我们不建议器件在该规范范围外运行。如果器件长时间工作在绝对最大极限条件下，其稳定性可能会受到影响。

Notes: If the device operating conditions over the maximum rating of the above-mentioned conditions, may cause permanent damage to the device. The above parameters is only part of the operating conditions the maximum, we do not recommend the device running outside the scope of this specification. If the device to work long hours under the condition of absolute maximum limit, its stability may be affected.

电性能参数 / Electrical Characteristics(Ta=25°C)

参数 Parameter	符号 Symbol	测试条件 Test Conditions	最小值 Min	典型值 Typ	最大值 Max	单位 Unit
The Output Voltage	V _{OUT}	V _{IN} =5.0V, I _{OUT} =10mA	2.94	3.00	3.06	V
The Output Current	I _{OUT}	V _{IN} =5.0V		150		mA
Load Regulation	ΔV _{OUT}	V _{IN} =5.0V 1mA ≤ I _{OUT} ≤ 100mA		25	60	mV
Low Dropout	V _{DIF}	I _{OUT} =10mA, ΔV _{OUT} =2%			100	mV
Static Power	I _{SS}	V _{IN} =5.0V		1.5	3.0	μA
Line Regulation	$\frac{\Delta V_{OUT}}{V_{OUT}} \cdot \frac{\Delta V_{IN}}{\Delta V_{IN}}$	5.0 ≤ V _{IN} ≤ 24V I _{OUT} =10mA			0.2	%/V
The Input Voltage	V _{IN}				24	V
Temperature Coefficient	$\frac{\Delta V_{OUT}}{\Delta T_A} \cdot V_{OUT}$	V _{IN} =5.0V, I _{OUT} =10mA -40°C ≤ T _A ≤ 85°C		100		ppm/°C

注：当 V_{IN}=5.0V，固定负载条件下使输出电压下降 2%，此时输入电压和输出电压的差值为低压差值 V_{DIF}。

Note: V_{DIF} is defined as the input voltage minus the output voltage that produces a 2% change in the output voltage from the value at V_{IN}=5.0V with a fixed load.

电参数曲线图 / Electrical Characteristic Curve

输入电压与输出电压/ The input voltage and output voltage

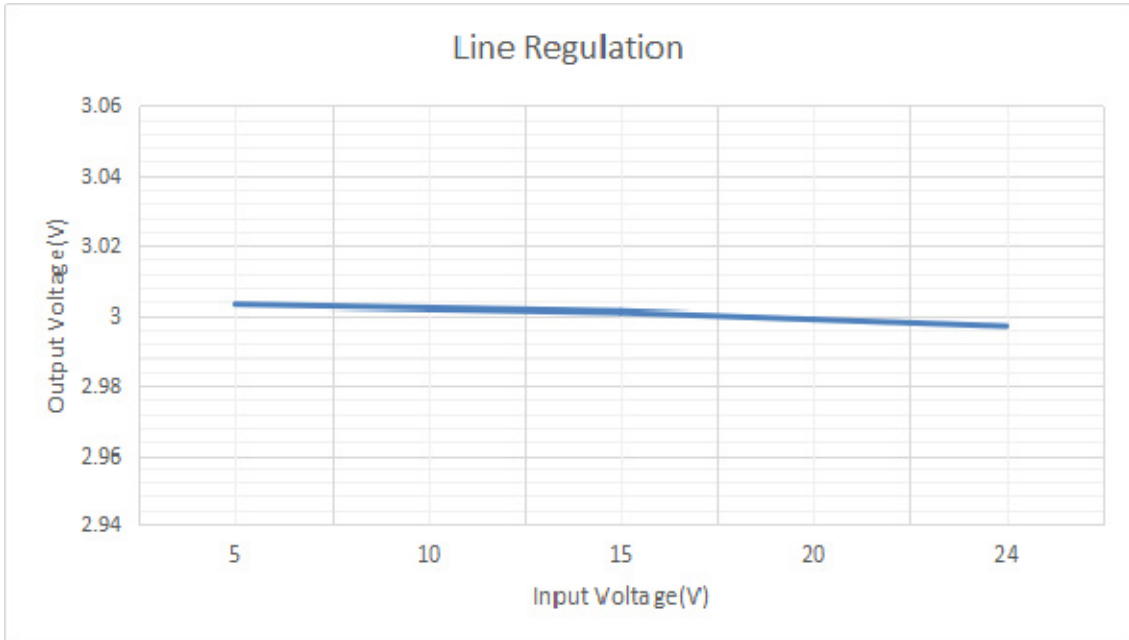

注：固定负载电流 $I_{OUT}=10mA$ 。

输出电压与负载电流/ The output voltage and load current

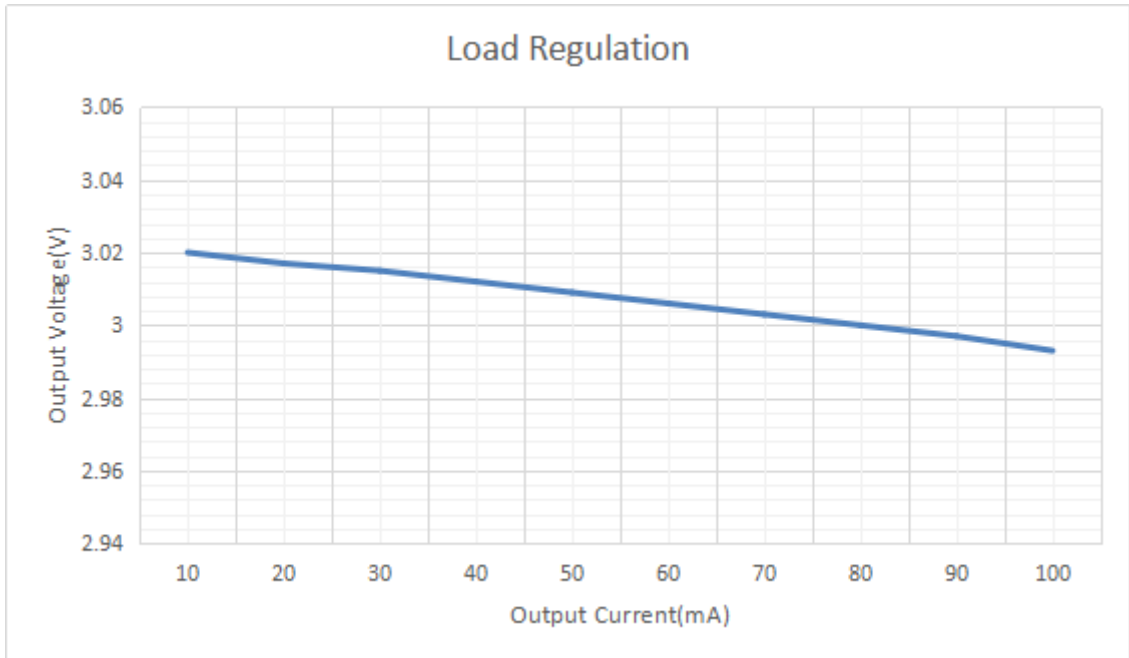

注：固定输入电压 $V_{IN}=5.0V$ 。

典型应用电路 / Typical Application Circuit

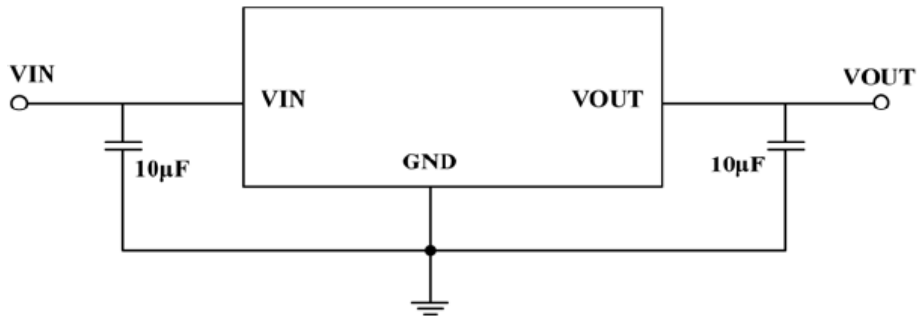

1. 应用时尽量将电容接到 VIN 和 VOUT 脚位附近。
2. 电路内部使用了相位补偿电路和利用输出电容的 ESR 来补偿。所以输出到地一定要接大于 2.2uF 的电容器，推荐使用钽电容。
3. 注意输入输出电压和负载电流的使用条件，避免 IC 内部的功耗超出封装允许的最大功耗值。

外形尺寸图 / Package Dimensions

SOT-89

单位: mm

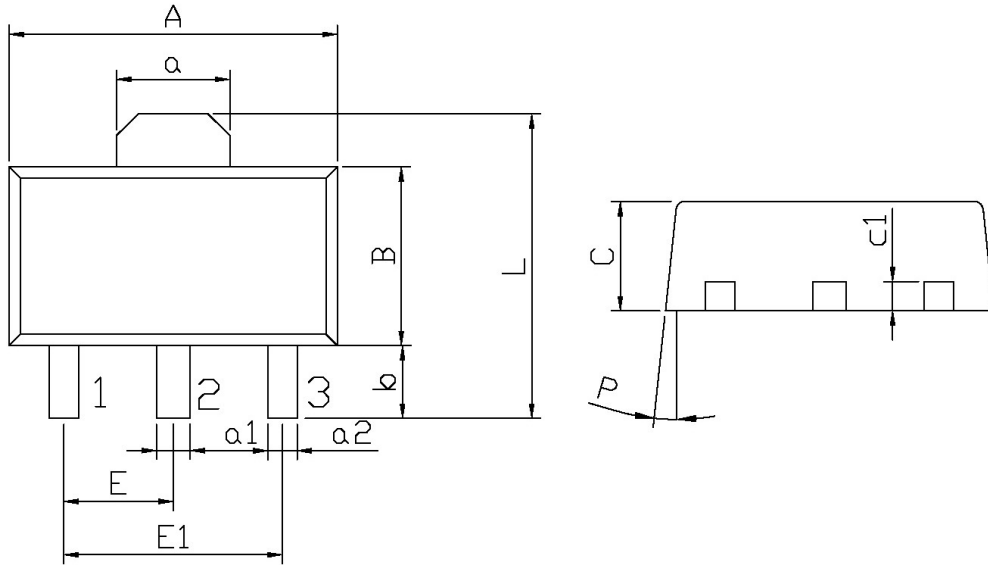

Symbol	Dimensions In Millimeters		Symbol	Dimensions In Millimeters	
	Min	Max		Min	Max
A	4.4	4.7	a1	0.36	0.56
B	2.35	2.65	a2	0.30	0.50
L	3.878	4.478	C	1.40	1.70
a	1.45	1.65	c1	0.35	0.50
E	1.40	1.60	P	6°	
E1	2.80	3.20			
b	0.80	1.20			

印章说明 / Marking Instructions

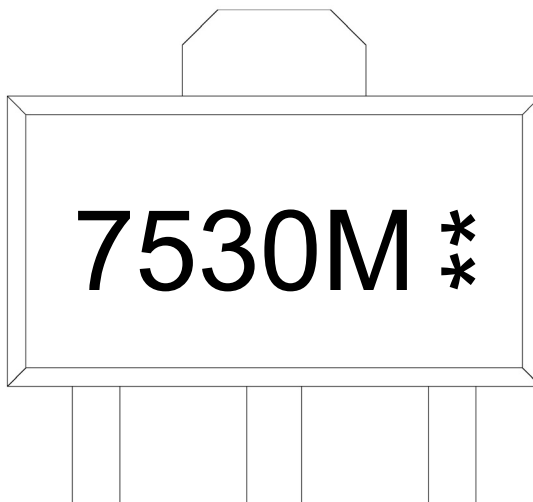

说明：

7530M：为型号代码

**：为生产批号代码，随生产批号变化

Note:

7530M: Product Type Code

** : Lot No. Code, code change with Lot No

回流焊温度曲线图(无铅) / Temperature Profile for IR Reflow Soldering(Pb-Free)

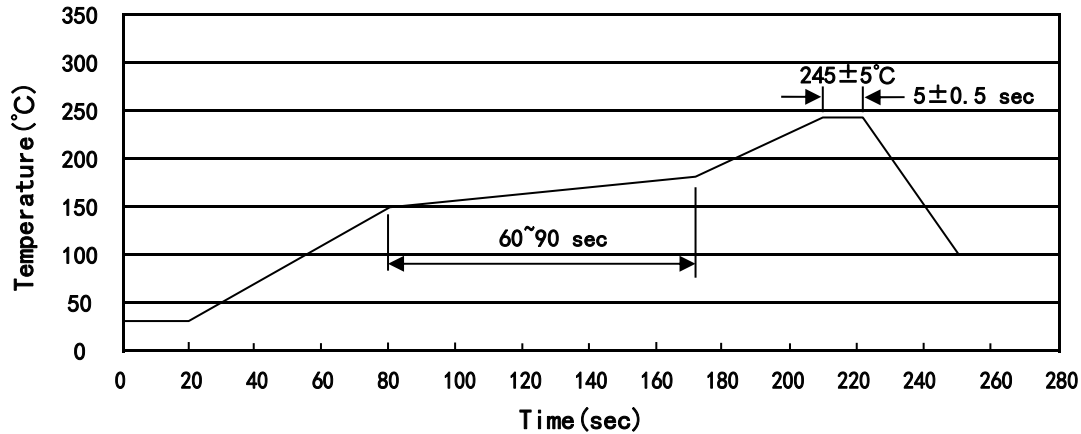

说明：

- 1、预热温度 150~180°C，时间 60~90sec;
- 2、峰值温度 245±5°C，时间持续为 5±0.5sec;
- 3、焊接制程冷却速度为 2~10°C/sec.

Note:

- 1.Preheating:150~180°C, Time:60~90sec.
- 2.Peak Temp.:245±5°C, Duration:5±0.5sec.
3. Cooling Speed: 2~10°C/sec.

耐焊接热试验条件 / Resistance to Soldering Heat Test Conditions

温度：260±5°C

时间：10±1 sec.

Temp.:260±5°C

Time:10±1 sec

包装规格 / Packaging SPEC.

卷盘包装 / REEL

Package Type 封装形式	Units 包装数量					Dimension 包装尺寸 (unit: mm ³)		
	Units/Reel 只/卷盘	Reels/Inner Box 卷盘/盒	Units/Inner Box 只/盒	Inner Boxes/Outer Box 盒/箱	Units/Outer Box 只/箱	Reel	Inner Box 盒	Outer Box 箱
SOT-89	1,000	10	10,000	4	40,000	7" ×12	210×205×205	445×435×230

使用说明 / Notices