

描述 / Descriptions

TO-252 塑封封装电压调整器。Voltage Regulator in a TO-252 Plastic Package.

特征 / Features

三端稳压调整器，输出电流高达 0.5A,内设过热保护和短路限制。

3-Terminal regulators ,output current up to 0.5A, internal thermal overload protection and short-circuit limiting.

用途 / Applications

电压调整器。

Voltage Regulator.

内部等效电路/应用电路 / Equivalent Circuit or Application Circuit

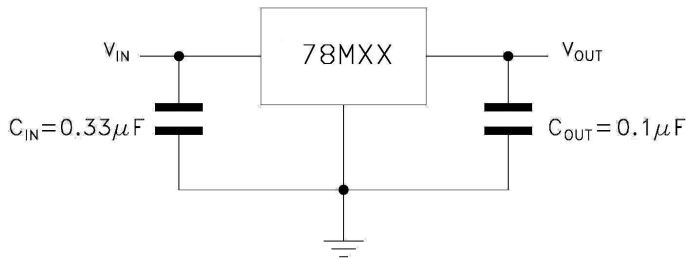

引脚排列 / Pinning

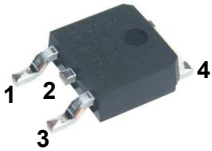

PIN 1 : IN PIN 2、4 : GND PIN 3 : OUT

印章代码 / Marking

见印章说明。See Marking Instructions.

极限参数 / Absolute Maximum Ratings(Ta=25°C)

参数 Parameter	符号 Symbol	数值 Rating	单位 Unit
Input voltage	V_i	35	V
Thermal Resistance Junction-ambient	$R_{\theta JA}$	100	°C/W
Thermal Resistance Junction-case	$R_{\theta JC}$	8.0	°C/W
Operating Junction Temperature Range	T_{OPR}	0~125	°C
Storage temperature range	T_{stg}	-65~150	°C

电性能参数 / Electrical Characteristics(Ta=25°C ,Vi=10V,Io=350mA , unless otherwise specified)

参数 Parameter	符号 Symbol	测试条件 Test Conditions	最小值 Min	典型值 Typ	最大值 Max	单位 Unit
Output voltage	V_o	$T_j=25^\circ\text{C}$	4.9	5	5.1	V
		$V_i=7V-20V$ $I_o=5mA-350mA$	4.8	5	5.2	V
Load Regulation	ΔV_o	$T_j=25^\circ\text{C}$ $I_o=5mA-500mA$			100	mV
		$T_j=25^\circ\text{C}$ $I_o=5mA-200mA$			50	mV
Line regulation	ΔV_o	$T_j=25^\circ\text{C}$ $V_i=7V-25V$			100	mV
		$T_j=25^\circ\text{C}$ $V_i=8V-25V$			50	mV
Output Noise Voltage	eN	$T_j=25^\circ\text{C}$ B=10Hz-100KHz		40		μV
Supply Voltage Rejection	SVR	f=120Hz $V_i=8V-18V$	62			dB
Short Circuit Current	Isc	$V_i=35V$ $T_j=25^\circ\text{C}$		300		mA
Quiescent Current	I _d	$T_j=25^\circ\text{C}$			6	mA
Quiescent Current Change	ΔI_d	$V_i=8V-25V$			0.8	mA
		$I_o=5mA-350mA$			0.5	mA
Output Voltage Drift	$\Delta V_o/\Delta T$	$I_o=5mA$		-0.5		mV/°C
Dropout Voltage	V _d	$T_j=25^\circ\text{C}$		2		V
Short Circuit Peak Current	I _{scp}	$T_j=25^\circ\text{C}$		700		mA

电参数曲线图 / Electrical Characteristic Curve

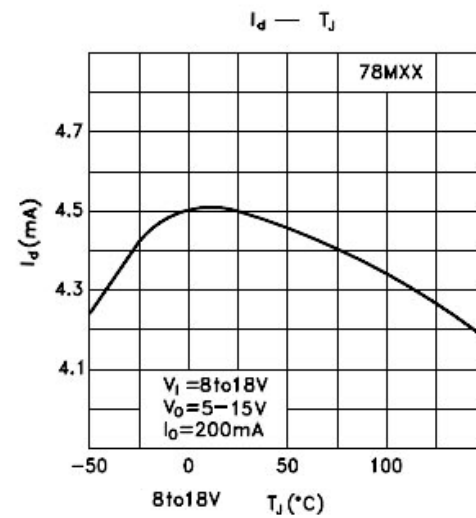
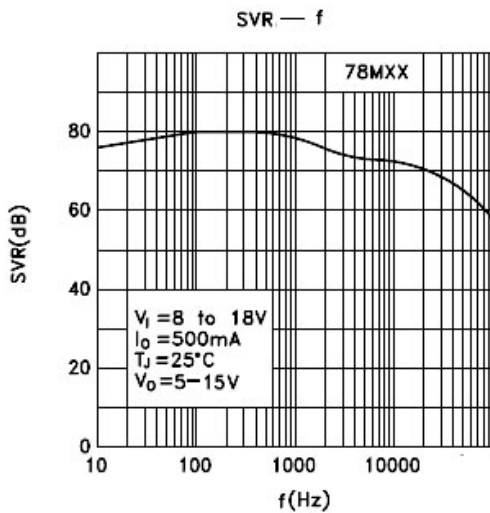
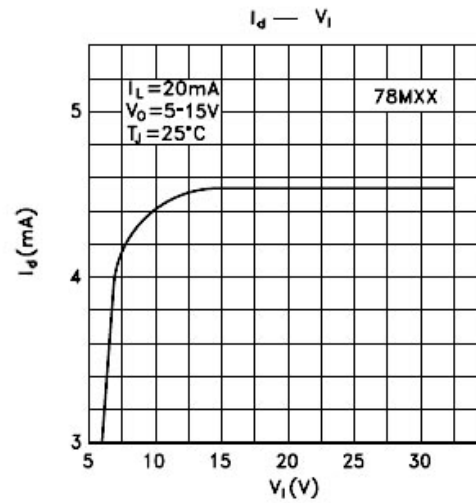
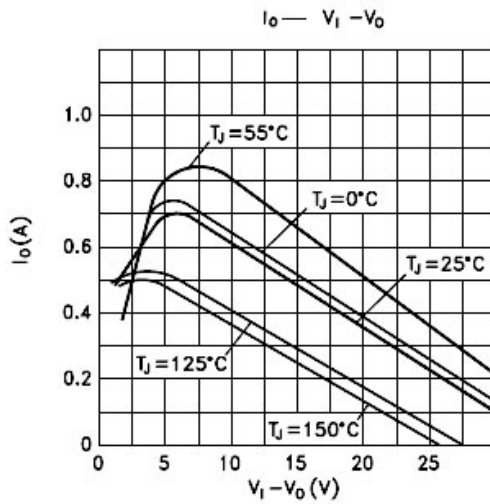
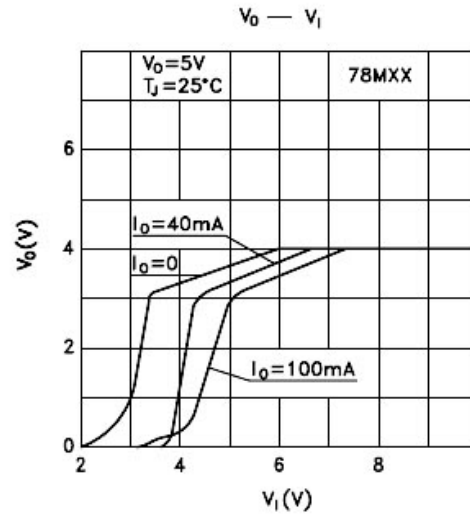
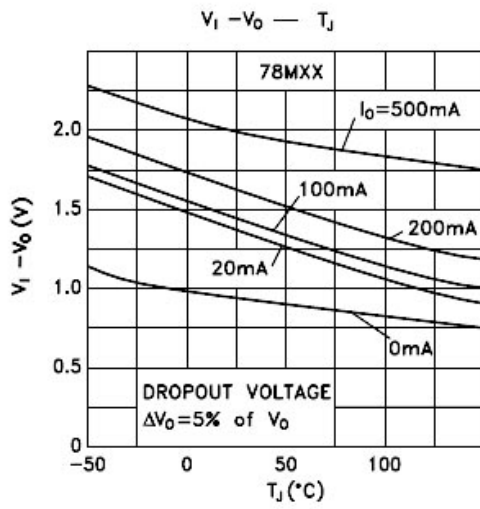

外形尺寸图 / Package Dimensions

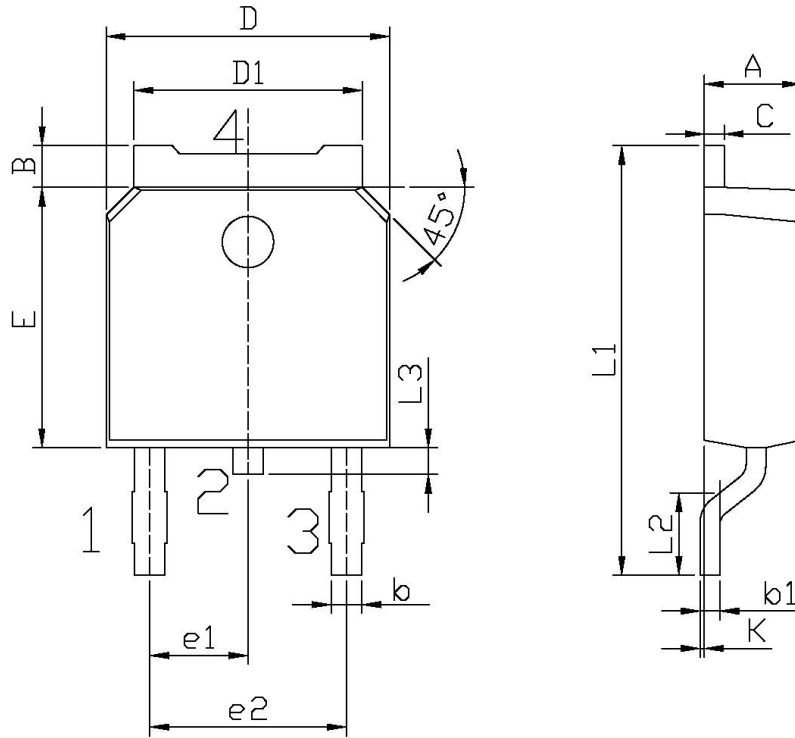

单位: mm

Symbol	Dimensions In Millimeters		Symbol	Dimensions In Millimeters	
	Min	Max		Min	Max
A	2.20	2.40	E	5.95	6.25
B	0.95	1.25	e1	2.24	2.34
b	0.70	0.90	e2	4.43	4.73
b1	0.45	0.55	L1	9.85	10.35
C	0.45	0.55	L2	1.70	2.00
D	6.45	6.75	L3	0.60	0.90
D1	5.10	5.50	K	0.00	0.10

TO-252

印章说明 / Marking Instructions

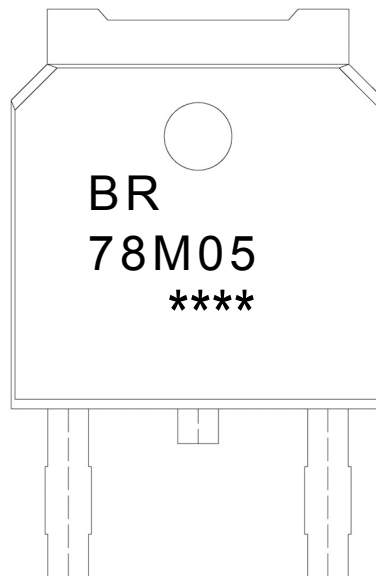

说明：

BR： 为公司代码

78M05： 为产品型号

****： 为生产批号代码，随生产批号变化。

Note:

BR: Company Code.

78M05: Product Type.

****: Lot No. Code, code change with Lot No.

回流焊温度曲线图(无铅) / Temperature Profile for IR Reflow Soldering(Pb-Free)



说明：

- 1、预热温度 150~180°C，时间 60~90sec；
- 2、峰值温度 245±5°C，时间持续为 5±0.5sec；
- 3、焊接制程冷却速度为 2~10°C/sec.

Note:

- 1.Preheating:150~180°C, Time:60~90sec.
- 2.Peak Temp.:245±5°C, Duration:5±0.5sec.
3. Cooling Speed: 2~10°C/sec.

耐焊接热试验条件 / Resistance to Soldering Heat Test Conditions

温度：260±5°C

时间：10±1 sec.

Temp:260±5°C

Time:10±1 sec

包装规格 / Packaging SPEC.

卷盘包装 / REEL

Package Type 封装形式	Units 包装数量					Dimension 包装尺寸 (unit: mm ³)		
	Units/Reel 只/卷盘	Reels/Inner Box 卷盘/盒	Units/Inner Box 只/盒	Inner Boxes/Outer Box 盒/箱	Units/Outer Box 只/箱	Reel	Inner Box 盒	Outer Box 箱
TO-252	2,500	2	5,000	6	30,000	13" ×16	360×360×50	380×335×366

套管包装 / TUBE

Package Type 封装形式	Units 包装数量					Dimension 包装尺寸 (unit: mm ³)		
	Units/Tube 只/套管	Tubes/Inner Box 套管/盒	Units/Inner Box 只/盒	Inner Boxes/Outer Box 盒/箱	Units/Outer Box 只/箱	Tube 套管	Inner Box 盒	Outer Box 箱
TO-251/252	75	48	3,600	5	18,000	526×20.5×5.25	555×164×50	575×290×180

使用说明 / Notices