

描述 / Descriptions

TO-220F 塑封封装 NPN 半导体三极管。Silicon NPN transistor in a TO-220F Plastic Package.

特征 / Features

击穿电压高、安全工作区宽、开关速度快,饱和压降低, 电流特性好、内设阻尼二极管。

High breakdown voltage, Wide SOA, High switching speed, Low saturation voltage, Excellent current characteristics, Built-in dumper diode.

用途 / Applications

用于电视机行输出和 CRT 监视器。

Horizontal deflection output for TV,CRT monitor.

内部等效电路 / Equivalent Circuit

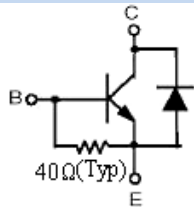

引脚排列 / Pinning



PIN1 : Base PIN 2 : Collector PIN 3 : Emitter

放大及印章代码 / h_{FE} Classifications & Marking

见印章说明。See Marking Instructions.

极限参数 / Absolute Maximum Ratings(Ta=25°C)

参数 Parameter	符号 Symbol	数值 Rating	单位 Unit
Collector to Base Voltage	V_{CBO}	1500	V
Collector to Emitter Voltage($V_{BE}=0$)	V_{CES}	1500	V
Collector to Emitter Voltage	V_{CEO}	800	V
Emitter to Base Voltage	V_{EBO}	5.0	V
Collector Current - Continuous	I_C	6.0	A
Peak Collector Current	I_{CP}	15.0	A
Collector Power Dissipation	P_C	2.0	W
Collector Power Dissipation	$P_C(T_c=25^\circ C)$	30	W
Junction Temperature	T_j	150	°C
Storage Temperature Range	T_{stg}	-55~150	°C

电性能参数 / Electrical Characteristics(Ta=25°C)

参数 Parameter	符号 Symbol	测试条件 Test Conditions	最小值 Min	典型值 Typ	最大值 Max	单位 Unit
Emitter to Base Breakdown Voltage	V_{EBO}	$I_E=500mA$ $I_C=0$	5.0			V
Forward Voltage	V_F	$I_F=3A$			2.0	V
Collector Cut-Off Current	I_{CBO}	$V_{CB}=1000V$ $I_E=0$			50	uA
		$V_{CB}=1500V$ $I_E=0$			1.0	mA
Emitter Cut-Off Current	I_{EBO}	$V_{EB}=4V$ $I_C=0$	40		130	mA
DC Current Gain*	h_{FE}^*	$V_{CE}=5.0V$ $I_C=3.0A$	5		10	
Collector to Emitter Saturation Voltage*	$V_{CE(sat)}^*$	$I_C=3.0A$ $I_B=0.75A$			2.5	V
Base to Emitter Saturation Voltage*	$V_{BE(sat)}^*$	$I_C=3.0A$ $I_B=0.75A$			1.5	V
Transition Frequency	f_T	$I_C=0.1A$ $f=0.5MHz$ $V_{CE}=10V$		3		MHz
Storage Time	T_{STG}	$V_{CC}=5V$ $I_C=0.5A(UI9600)$	3		8	us
Fall Time	T_f				0.8	us

*脉冲测试：脉冲周期 $\leq 300\mu s$ ，占空比 $\leq 2\%$ 。

*pulse test: pulse width $\leq 300\mu s$, duty cycle $\leq 2\%$ 。

电参数曲线图 / Electrical Characteristic Curve

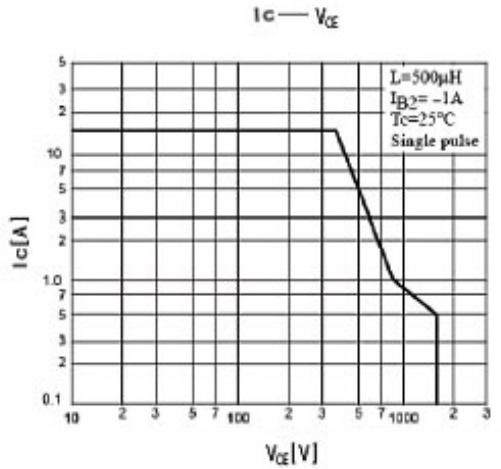
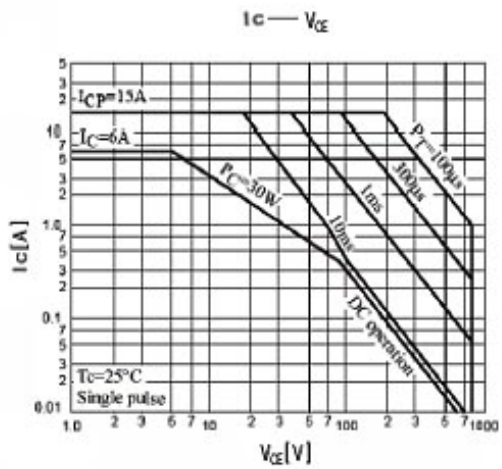
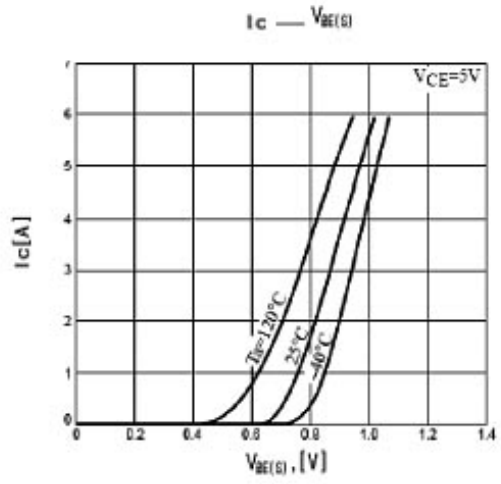
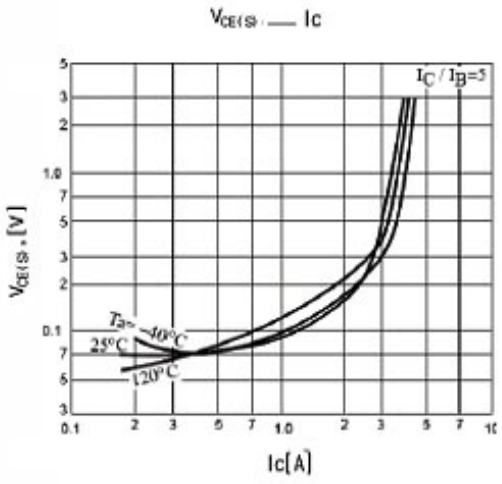
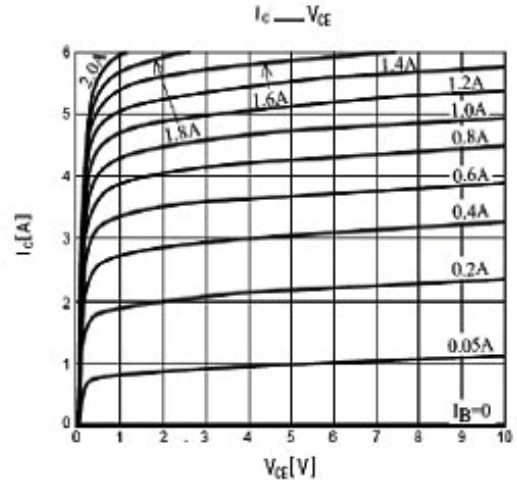
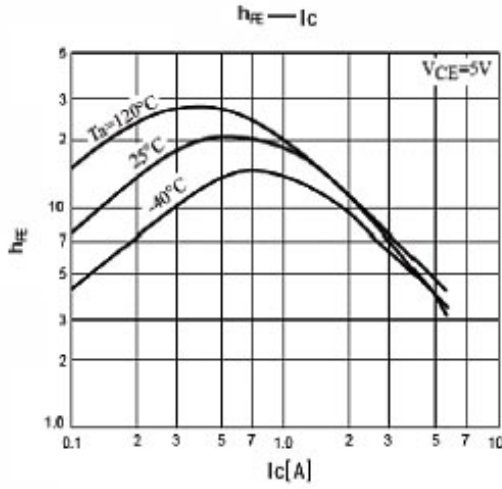

外形尺寸图 / Package Dimensions

T0-220F

单位: mm

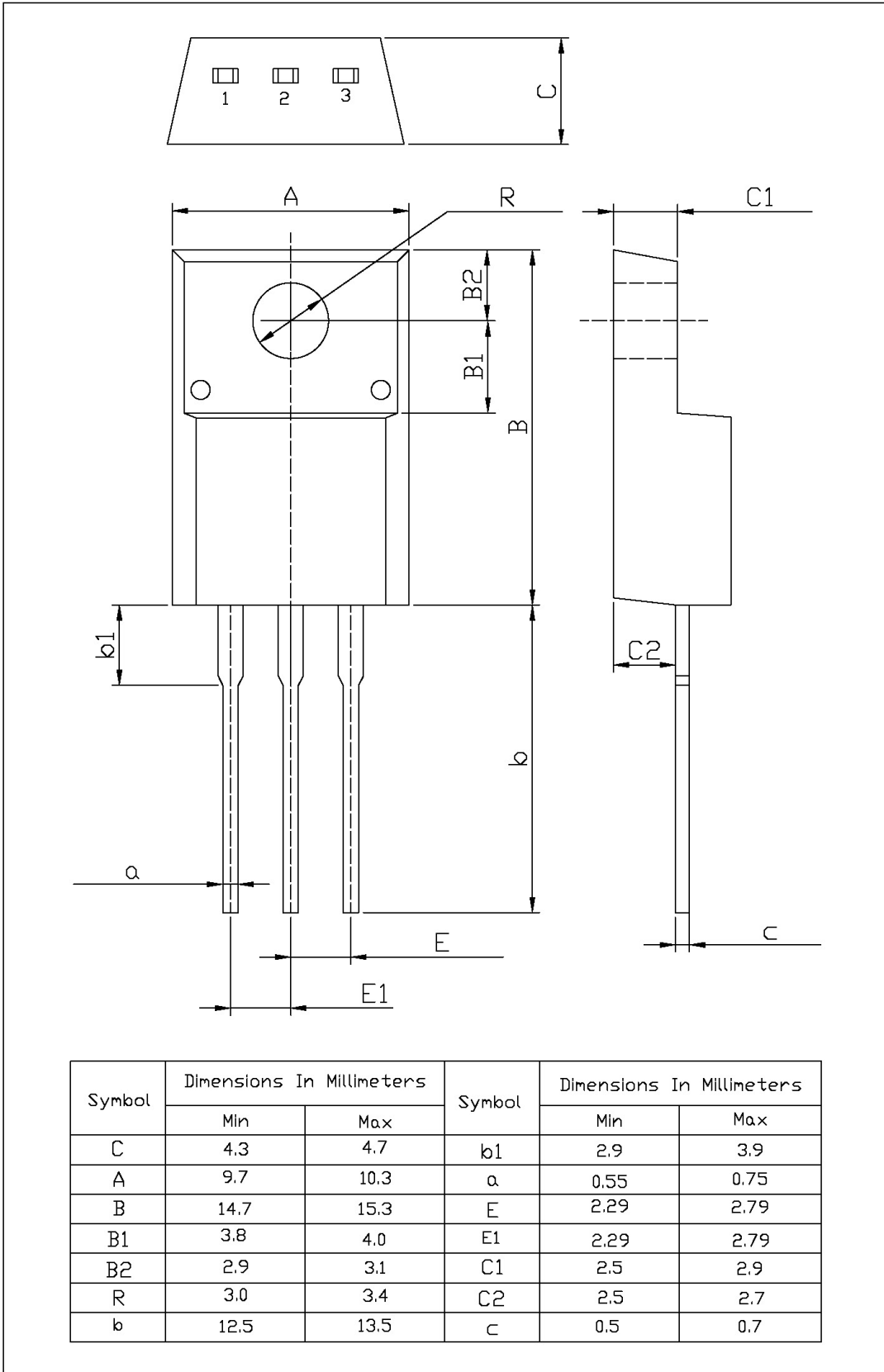

印章说明 / Marking Instructions

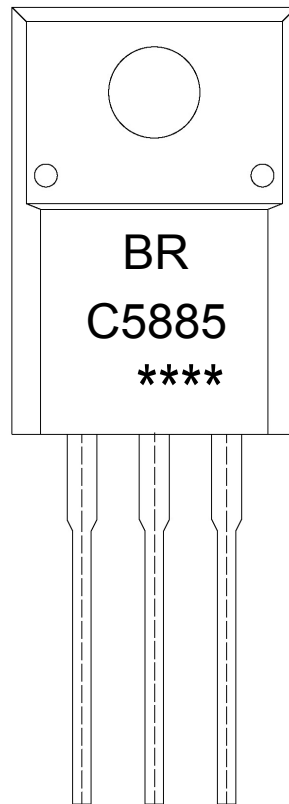

说明：

BR： 为公司代码

C5885： 为型号代码

****： 为生产批号代码，随生产批号变化。

Note:

BR: Company Code

C5885: Product Type.

****: Lot No. Code, code change with Lot No.

波峰焊温度曲线图(无铅) / Temperature Profile for Dip Soldering(Pb-Free)



说明：

- 1、预热温度 25 ~ 150°C，时间 60 ~ 90sec；
- 2、峰值温度 255±5°C，时间持续为 5±0.5sec；
- 3、焊接制程冷却速度为 2 ~ 10°C/sec.

Note:

- 1.Preheating:25~150°C, Time:60~90sec.
- 2.Peak Temp.:255±5°C, Duration:5±0.5sec.
3. Cooling Speed: 2~10°C/sec.

耐焊接热试验条件 / Resistance to Soldering Heat Test Conditions

温度：270±5°C 时间：10±1 sec. Temp.:270±5°C Time:10±1 sec

包装规格 / Packaging SPEC.

散件包装 / BULK

Package Type 封装形式	Units 包装数量					Dimension 包装尺寸 (unit: mm ³)		
	Units/Bag 只/袋	Bags/Inner Box 袋/盒	Units/Inner Box 只/盒	Inner Boxes/Outer Box 盒/箱	Units/Outer Box 只/箱	Bag 袋	Inner Box 盒	Outer Box 箱
TO-220/F	200	10	2,000	5	10,000	135×190	237×172×102	560×245×195

套管包装 / TUBE

Package Type 封装形式	Units 包装数量					Dimension 包装尺寸 (unit: mm ³)		
	Units/Tube 只/套管	Tubes/Inner Box 套管/盒	Units/Inner Box 只/盒	Inner Boxes/Outer Box 盒/箱	Units/Outer Box 只/箱	Tube 套管	Inner Box 盒	Outer Box 箱
TO-220/F	50	20	1,000	5	5,000	532×31.4×5.5	555×164×50	575×290×180

使用说明 / Notices